

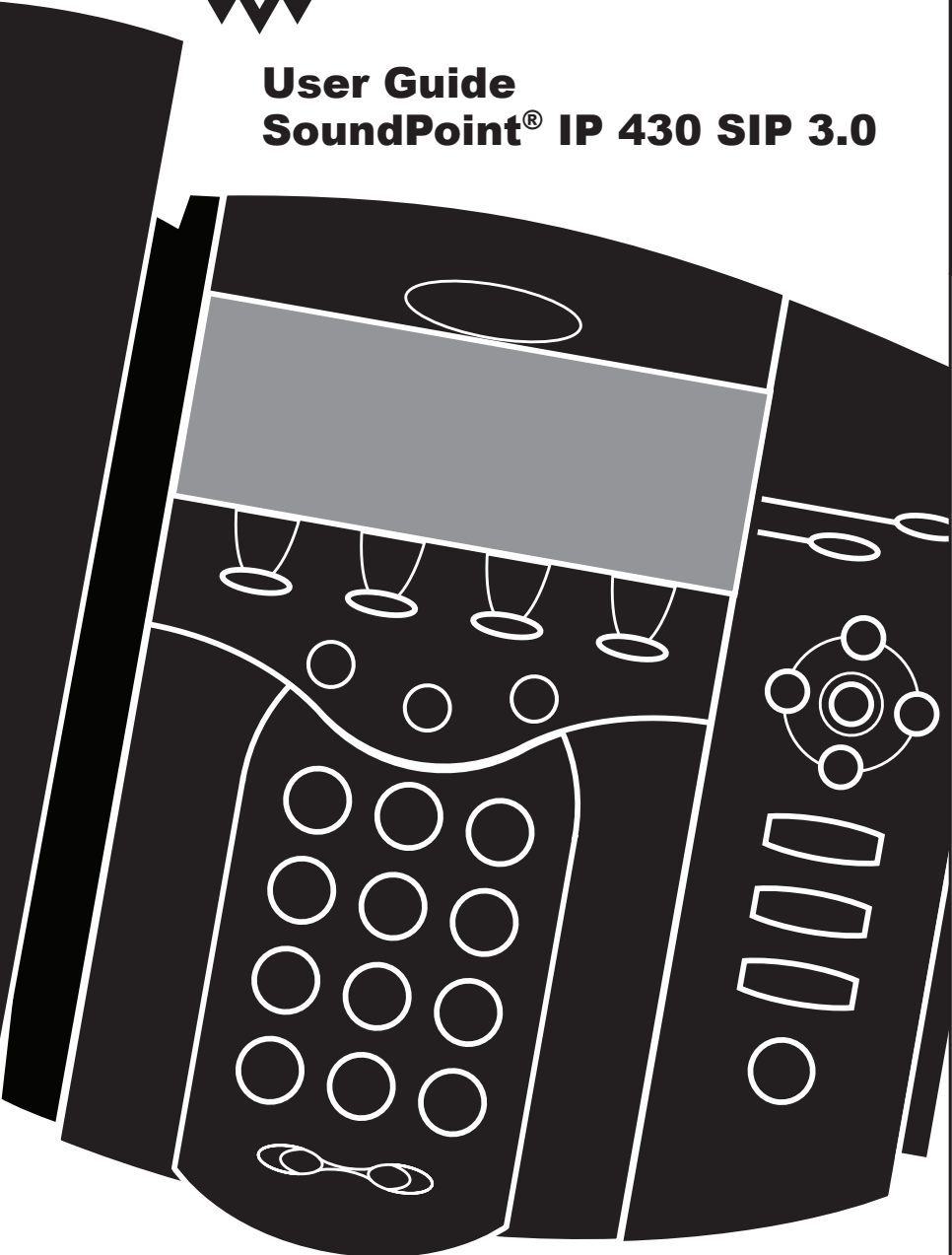

# POLYCOM®

## **User Guide SoundPoint® IP 430 SIP 3.0**



# Contents

<b>Introduction .....</b>	<b>1</b>
<b>Parts List .....</b>	<b>1</b>
<b>Installing SoundPoint® IP 430 SIP.....</b>	<b>2</b>
Connecting Network and Power Source .....	2
Connecting the Handset and Optional Headset.....	3
Attaching the Base.....	3
<b>Features .....</b>	<b>5</b>
<b>Key Descriptions .....</b>	<b>6</b>
<b>Using SoundPoint® IP 430 SIP.....</b>	<b>7</b>
Placing a Call .....	7
Answering a Call .....	8
Call Hold and Resume .....	8
Multiple Calls on Hold .....	8
Microphone Mute.....	8
General Key Use.....	9
Local Conferencing.....	9
Splitting a Conference .....	9
Transferring a Call.....	10
Call Timer.....	10
Ending a Call .....	10
Redial.....	10
Call Forwarding.....	11
Volume Adjustment .....	11
Do Not Disturb.....	11
Time and Date .....	12
Headset Memory Mode .....	12
Headset Hookswitch .....	12
Display Contrast.....	12
Ring Type .....	13
Call Lists.....	13
Contact Directory .....	13
Speed Dial .....	15
Multiple Lines.....	16
Multiple Keys per Line.....	16
Multiple Call Appearances .....	17
Shared Lines .....	18
Voice Mail .....	18

---

Distinctive Ringing / Call Treatment ..... 19  
Multilingual Support (Localization) ..... 19  
Phone Reboot ..... 20

**Optional Features ..... 20**

Text Messaging ..... 20  
Presence / Status / Buddy Lists ..... 21

**Troubleshooting ..... 23**

**Safety and Compliance..... 24**

Part 15 Rules ..... 24  
Class B Digital Device or Peripheral..... 24  
Modifications..... 25  
Installation Instructions..... 25  
Plug Acts as Disconnect Device ..... 25  
Industry Canada (IC) ..... 25  
CE & VCCI Mark..... 25

**Polycom Limited Warranty  
and Limitation Liability..... 25**

**Exclusions ..... 26**

**Warranty Exclusive..... 26**

**Service Agreements..... 26**

**Limitations of Liability ..... 27**

**Disclaimer..... 27**

**Governing Law ..... 27**

**Copyright Notice ..... 27**



## Introduction

Thank you for choosing SoundPoint® IP 430 SIP, a full-duplex, hands-free phone. This unit provides business telephony features and functions such as Multiple Call Appearances, Call Hold, Transfer, and Conference over an IP network. In this User Guide, you will find everything you need to quickly use your new phone.

Be sure to verify with your system administrator that your network is prepared for configuring your SoundPoint® IP 430 SIP phone. As well, be sure to read the Parts List, and the Safety Notices section in this guide before you set up the SoundPoint® IP 430 SIP phone.

## Parts List

The following items are included in your SoundPoint® IP 430 SIP package. Check this list before installation to ensure that

you have received each item. If you are missing any items, please contact your system administrator.

### Polycom SoundPoint® IP 430 SIP

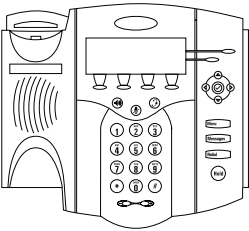

### Power Adapter

(Not shown: Country-specific AC cord provided)

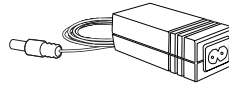

### Handset & Handset Cord

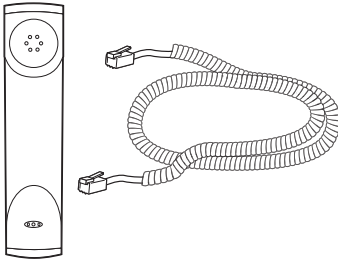

### Phone Base

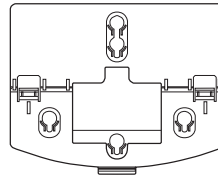

### Network Cable

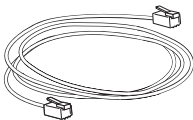

### Quick Start Guide



# Installing SoundPoint® IP 430 SIP

This section provides basic installation instructions and information for obtaining the best performance with the SoundPoint® IP 430 SIP phone. If you require additional information or assistance with your new phone, please contact your system administrator.

The SoundPoint® IP 430 SIP User Guide includes regulatory compliance information that your system administrator should review. It can also be found at [www.polycom.com](http://www.polycom.com).

## Connecting Network and Power Source

### AC Power Option

Connect the supplied Network cable between the LAN jack on the phone and the LAN port on the wall or hub/switch device. Connect the DC plug on the power adapter to the DC 24V jack marked on the phone. Connect the country-specific AC cord to the power adapter.

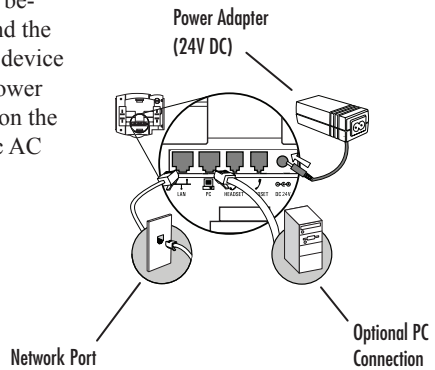

### In-Line Power Option

If the phone is connected to a compatible Ethernet switch that can provide in-line power, the phone will use that power option. Simply plug the supplied Network cable between the LAN jack on the phone and an available Power and Data port on the In-Line Power switch.

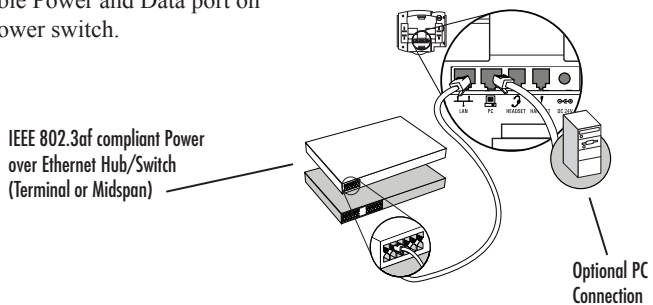

## Connecting the Handset and Optional Headset

1. Connect the short, straight end of the phone cord to the handset and the corresponding longer straight end of the cord to the handset jack on the back of the phone.
2. Connect the headset (optional accessory) to the headset jack on the back of the phone.

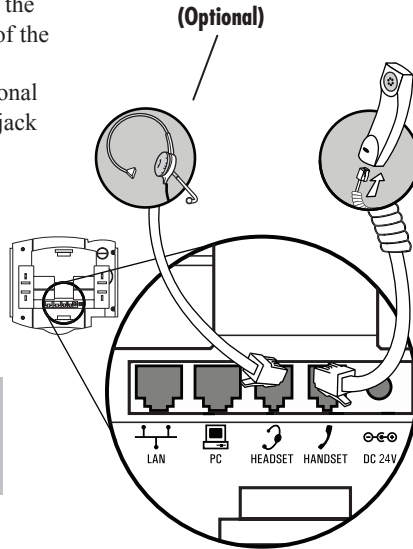

*For information on headsets, please visit [www.polycom.com](http://www.polycom.com) and choose the Support link.*

## Attaching the Base

The base unit can be attached to the SoundPoint® IP 430 in one of two ways:

### Deskmount Method

1. Place all cords in the recessed area above the modular jacks as shown.
2. Align the two protrusions on the bracket with their corresponding holes in the phone and snap them together to lock the base to the phone.

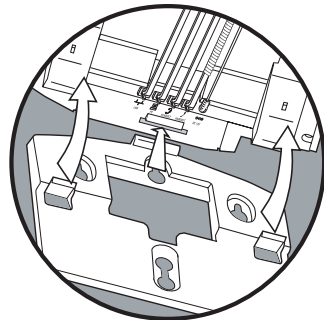
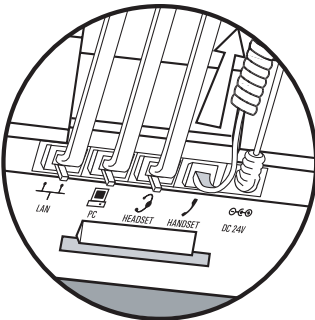

## Wallmount Method

1. Place all cords in the recessed area above the modular jacks as shown in previous example.
2. On the back of the phone, remove the key located behind the hook-switch. (See below.)

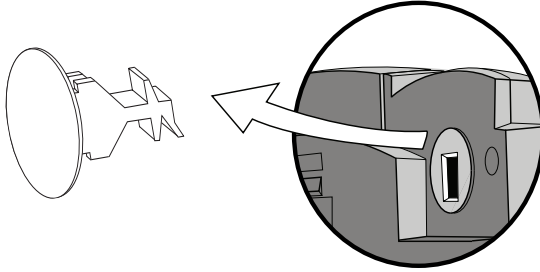

3. Reposition it so that the end tab (at 45° angle) is facing up. (See below.) This will ensure that the handset remains in place within the cradle in this position.

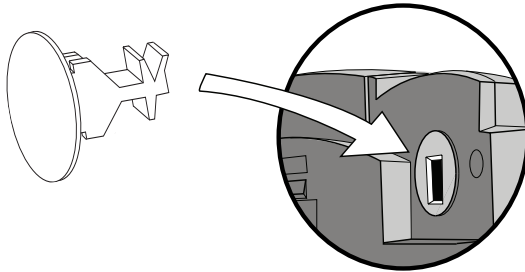

4. With mounting tab of the base unit facing up, fasten the base unit to wall using wall anchors (not included). Snap the SoundPoint® IP 430 into place.

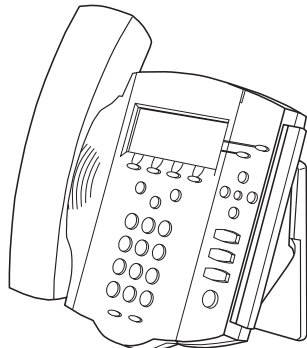
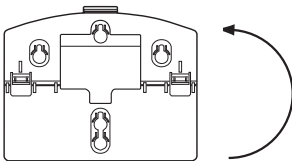

# Features

**Line Indicators** Individual multi-color LEDs display a dynamic call state.

## Soft Keys

The screen will display labels for these keys, to identify their context-sensitive functions.

## Speakerphone

## Microphone Mute

## Dial Pad

These 12 keys provide the 10 digits, alphabetic, and special characters available in context sensitive applications.

## Volume Adjustment Keys

Use these to adjust the volume of the handset, headset, speaker, and ringer.

## Line/Speed Dial Keys

## Display Control Keys

Use the arrow keys to scroll through the displayed information.

## Feature Keys

Access important features using these keys.

## Hold

## Headset

## Hookswitch

## Speaker

For ringer and hands-free audio output.

## Indicator

This will alert you to new messages, and other events.

## Graphic Display

Shows information about calls, messages, soft keys, time, date, and other relevant data.





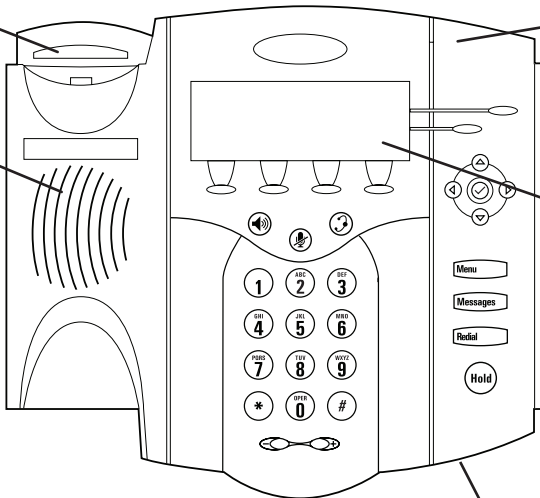
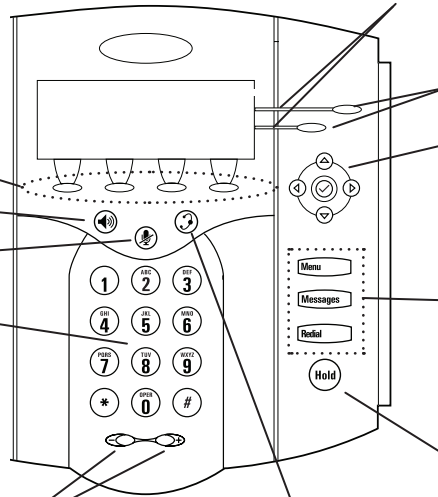



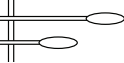

## Hands-free Microphone

This works best when the phone is placed on a hard, flat surface.





## Key Descriptions



Feature Key	Description
	Allows for hands-free communication during calls.
	Mutes audio transmission locally during calls.
	Allows you to place and receive calls through an optionally connected headset.
	Line or Speed Dial keys with LED indicators.
	Dials last connected party from the phone.
	Places current active call in Hold state.
	Access Message Center and Instant Messages.
	Access local and server features.
	Select control for options and text within local menus.
	Scrolling of lists and control of text/number entry on display.
	Soft keys to select from various context-sensitive options.
	Volume keys to adjust audio and ringer volume.
<b>Dial Pad</b>	General dialing and alphanumeric entry (incl. special characters).

# Using SoundPoint® IP 430 SIP

## Placing a Call

### Using the Handset:

1. To obtain dial tone, pick up the handset.
2. Dial the desired number.

*During a call, you can alternate between handset, headset, or hands-free modes by pressing the  or  keys, or picking up the handset.*



### Using Hands-Free Speakerphone Mode:

1. With the handset on-hook, press any assigned line key, , or **NewCall** to obtain dial tone.
2. Dial the desired number.

### Using the Headset:

1. With the optional headset connected, press any assigned line key, , or **NewCall** to obtain dial tone.
2. Dial the desired number.

*See also Headset Memory Mode.*

You also have the option to dial directly from the dial pad without first getting dial tone. Simply enter the number then lift the handset, press the **Dial** soft key, or press the  or  keys.

In all cases, the active call will appear on the display showing call duration and destination.

*To obtain the IP address of your phone, press  followed by Status, Platform and Phone. The IP address is listed together with other phone information.*

## Answering a Call

### Using the Handset:

Pick up the handset.

### Using Hands-Free Speakerphone Mode:

Press , or with the handset on hook press the line key with the active indicator, or the **Answr** soft key.

### Using the Headset:

Press  to answer the call through an optionally connected headset.

In all cases, the active call will appear on the display showing call duration and destination.

*Incoming calls may be ignored by pressing the **Reject** soft key or invoking **Do Not Disturb** during ringing. Note that **Do Not Disturb** stays active when the call is dropped and will remain so until toggled off.*

---

## Call Hold and Resume

During a call, press  or the **Hold** soft key. The call will be placed on hold and this will be indicated on the display. Press the **Resume** soft key, or the line key to retrieve the call.

---

## Multiple Calls on Hold

If multiple calls are on hold on a single line key, use the arrow keys to switch between the calls then press the **Resume** soft key to retrieve the desired call. If more than two calls are on hold on a single key, an indication will appear on the display, for example “2/3” shows that this is the

second call out of three calls.

If calls are on hold on more than one line key, the details of the calls on any line key can be viewed by pressing that line key and holding it down for a few seconds. If a line key is pressed briefly, the first call on hold on that line key will be retrieved.

---

## Microphone Mute







During a call, press . The LED on the phone lights up and a flashing microphone on the display indicates that the other party (parties) cannot hear you.

Microphone Mute applies to all modes: handset, headset, and hands-free. You can still hear all other parties while Mute is enabled.

To turn off Microphone Mute, press  again.

## General Key Use

To navigate through menus and to enter data, these are useful tips:

1. Use  and  to scroll through lists. In some lists the  and  keys can be used as “Page Up” and “Page Down”.
2. When menus have submenus, use  and  to move one level down or one level back up.
3. Press  to exit from any menu.
4. To enter text using the dial pad, press the number keys one or more times. For example, for ‘A’ press ‘2’ and

for ‘C’ press ‘222’. When in text entry mode the display title will show whether keys will generate numbers (1), upper-case (A) or lower-case (a) characters and the **1/A/a** soft key can change this.

---

## Local Conferencing

You can create a conference with two other parties using the phone’s local conferencing feature.

1. Place a call to the first party.
2. Press the **Cnfrnc** soft key to create a new call (the active call is placed on hold).
3. Dial the phone number of the second party or use the arrow keys to access speed dial numbers, missed, placed and received call lists. From one of these lists press the **Dial** soft key.

*Ending the call on the conference originator’s phone will not end the conference; the other two parties can continue to talk.*

4. When the second party answers, press the **Cnfrnc** soft key again to join all parties in the conference, or press the **Split** soft key to put the first call on hold and keep the second call as the active call.

A conference may be created at any time between an active call and a call which is on hold (on the same line or another line) by pressing the **Join** soft key.

---

## Splitting a Conference

When a conference has been established, a **Split** soft key is available. Pressing this key will split the conference into two calls on hold.

## Transferring a Call

1. During a call, press the **Trnsfr** soft key (the active call is placed on hold).
2. Dial the number to which you want to transfer the call.

OR

Use the arrow keys to access speed dial numbers, missed, placed, and received call lists. From one of these lists, press the **Dial** soft key.

3. Press the **Trnsfr** soft key again to complete the transfer. This can be done as soon as the ringback sound is heard or you can wait until the third party answers and talk to them before completing the transfer.

Transfer may be cancelled during establishment by pressing the **Cancel** soft key. The original call is resumed.

*A blind transfer (without consultation) can also be supported by pressing the **Blind** soft key.*

## Call Timer

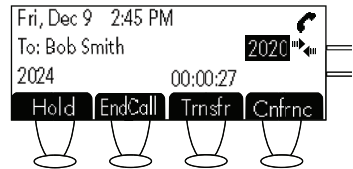

Call duration on an active call is monitored through a local call timer. This is visible within the active call window on the display.



## Ending a Call



Press the **EndCall** soft key.

OR

Replace the handset, or press  if in Hands-free Mode, or  if in Headset Mode.

## Redial

Press  to dial the last call placed from your phone.

To redial another previously dialed number, press  from the phone's idle display, and press  again to place the call

OR

Press  and select *Features, Call Lists, Placed Calls* to access the list.

## Call Forwarding

Calls may be forwarded to another extension as follows:

1. Press the **Fwd** soft key from the phone's idle display or press  and select *Features* and *Forward* at any time.
2. (Optional) If multiple lines are in use, select which line to forward.
3. Enter a number or URL to forward all future calls to.
4. Press the **Enable** soft key to confirm Call Forwarding.

Idle display returns with a moving arrow on the line label to confirm Call Forwarding enabled.

To turn call forwarding off:

1. Press the **Fwd** soft key from the phone's idle display or press  and select *Features* and *Forward*.
2. (Optional) If multiple lines are in use, select which line to disable.
3. Press the **Disabl** soft key.

Idle display returns and the line indicator now displays the regular icon.

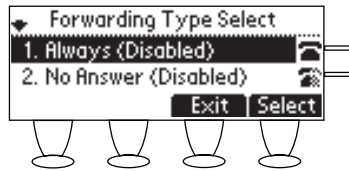

*Call forwarding is not available on shared lines.*

## Volume Adjustment

Press the volume keys to adjust handset, headset, and hands-free speaker volume during a call. Pressing these keys in idle state adjusts the ringer volume.

*To conform to regulatory requirements, handset and headset volume will return to a preset level after each call. Hands-free volume settings will be maintained across calls.*

## Do Not Disturb

To prevent the phone from ringing on incoming calls, press  and select *Features, Do Not Disturb*. A flashing icon and text on the display indicates that Do Not Disturb is on.

Calls received while Do Not Disturb is enabled are logged in the *Missed Calls* list.



To turn off Do Not Disturb, press  and select *Features*, and then

deselect *Do Not Disturb*.

(Optional) If multiple lines are in use, Do Not Disturb can be set on a line-by-line basis. Contact your system administrator for further details. When Do Not Disturb is enabled for a particular line, this is indicated by a flashing “X” beside the line indicator on the display.

## Time and Date



Time and Date is clearly displayed on the SoundPoint® IP 430 SIP phone. If the phone cannot obtain a time and date from the server, the display will flash. Contact your system administrator if either time or date is incorrect. You have control over the format of the display and can turn it off. Select options which are right for you as follows:

1. Press .
2. Select *Settings* followed by *Basic*, *Preferences*, *Time & Date*.
3. Select from *Clock Date*, *Clock Time*, *Clock Order* or *Enable / Disable*.
4. Scroll through the options via the up and down arrow keys.
5. Press **Select** to confirm and  to return directly to the idle display.

---

## Headset Memory Mode

As an option, the headset can be permanently enabled. This is especially useful for regular headset users. To do this:

1. Press .
2. Select *Settings* followed by *Basic*, *Preferences*, *Headset Memory*.
3. Use the up or down arrows and **Select** soft key to enable Headset Memory Mode.
4. Press  to return to the main menu.

Subsequent calls to or from this phone using the headset will cause the headset key to flash. Pressing the line keys or the **Answer** soft key to receive a call will now connect to the user's headset automatically.



Repeat steps 1-3 and select *Disabled* to turn Headset Memory Mode off.

---

## Headset Hookswitch

This feature enables electronic hookswitch support.



To select a headset that supports electronic hookswitch:

1. Press .
2. Select *Settings* > *Basic* > *Preferences* > *Headset* > *Analog Headset Mode*.
3. Use  or  to select your headset and press the **Select** soft key.

---

## Display Contrast

To adjust the contrast on the display to a comfortable level:

1. Press . Select *Settings* followed by *Basic*, *Contrast*.
2. Pressing the **Up** or **Down** soft keys or volume keys will increase or decrease the display contrast.
3. Press the **Ok** or **Cancel** soft keys to accept or reject changes.
4. Press  or the **Exit** soft key to return to the idle display.

## Ring Type

Many ring types are available including a “Silent Ring”. You can select different rings to distinguish between lines or to have a different ring from your neighbor’s phone.

To change the incoming ring:

1. Press **Menu**. Select *Settings* followed by *Basic, Ring Type*.
2. (Optional) If multiple lines are used, first select which line to change.
3. Using the arrow keys, highlight the desired ring type. Press the **Play** soft key to hear the selected ring type.

*If “Silent Ring” is selected, incoming calls can only be answered by pressing the **Answer** soft key.*

4. Press **Select** to change to the selected ring type.
5. Press **Menu** or the **Exit** soft key to return to the idle display.

See also **Distinctive Ringing / Call Treatment**.

---

## Call Lists

A local list of calls missed, received, and placed is maintained by the phone (up to 100 for each).

Press **Menu** followed by *Features, Call Lists* and *Missed, Received, or Placed Calls* as desired. Call information will be displayed. From this screen:

1. Choose **Edit** to amend the dial string before dialing.
2. Choose **Dial** to return the call.
3. Choose **Exit** to return to the previous menu.

For additional choices, press **More** followed by:

4. **Info** to view information about the call.
5. **Save** to store the contact to the Contact Directory.
6. **Clear** to delete the call from the list.

Press **More** and **Exit** soft keys to return to the idle display.

*To quickly view respective call lists from the idle display:*

Press **Down Arrow** for Placed Calls.  
Press **Up Arrow** for Received Calls.  
Press **Left Arrow** for Missed Calls.

---

## Contact Directory

In addition to a directory of missed, placed, or received calls, large number of contacts in your phone’s local contact directory. Contact your system administrator for the exact number.

You can dial or search for a contact in this directory. You may be able to add, edit, and delete contacts.

*Contacts can be easily added from Call Lists. See **Call Lists** for more information.*



You may have read access to portions of your corporate directory through your phone. The contacts that you can see are determined by your system administrator. You can add contacts from the corporate directory to your local contact directory

### To add or edit a contact:

1. Press **Directories** and select *Contact Directory*.
2. Press **Add** to enter another contact into the phone's database or highlight an existing entry then press **Edit**.
3. Enter first and/or last name from the keypad. Press the **1/A/a** soft key to select between numeric and upper/lower case alphanumeric modes. Press the **Encoding** soft key to access special characters in other languages.
4. Enter the Contact number. This is a required field and it must be unique (not already in the directory).
5. Speed Dial Index, Ring Type and Divert Contact may be left blank.
6. Use **▶** and **◀** to switch between Enabled and Disabled settings for the last four fields.
7. Press **Save** to confirm or **Cancel** to abandon the changes then press **Exit** to return to the idle display.

### To search for a particular contact:

1. Press **More** and then **Search** from the *Contact Directory* menu.
2. Using the dial pad, enter the first few characters for First or Last names.
3. Press **Search** to search for contacts.
4. Successful matches can be dialed from the resulting screen.

### To search for a particular contact in the corporate directory:

1. Press **Directories**.
2. Select *Corporate Directory*.
3. Search for the contact in one of the following ways:
  - a Use **▲** and **▼** to scroll through the list to find the contact.  
You can also use the \* key to Page Up and the # key to Page Down.
  - b Press the Search soft key, then enter the first few letters or numbers of the first name, last name, or any other parameter displayed in the list.

Press the **Submit** soft key.

- c Using the dial pad, enter the first few characters of the contacts's last name. The characters that you enter appear on the second line of the graphic display.

The entries whose last name begin with the characters that you entered (or are alphabetically next to the characters that you entered) appear on the graphic display.

### Add Contacts From Corporate Directory:

1. Press .
2. Select Corporate Directory.
3. Search for the contact. (See **To search for a particular contact in the corporate directory**, on previous page.)
4. Press the **View** soft key. The contact's information appears on the graphic display.
5. Press the **Save** soft key to save the contact in the local contact directory.

“Entry saved” appears on the graphic display. Only the first name, last name, and phone number are saved.

If the contact already exists in the contact directory, “Entry already exists” appears.

6. Press  or the **Exit** soft key repeatedly to return to the idle display.



---

## Speed Dial

Pre-assigned numbers can be associated with speed dial entries for rapid automated dialing. Speed Dial entries are consecutively placed next to assigned line keys

on the phone. When a new entry is added to the Contact List, it is automatically assigned the next available speed dial index.

### Example: To change a Speed Dial key assignment:

1. Press  and select *Features, Contact Directory*. Highlight an existing directory entry and press **Edit**.  
OR press and hold the line key which already has a speed dial number assigned to it. That contact in the directory will automatically be displayed.
2. If a speed dial index already exists, delete it by pressing the  key and then the << softkey.
3. If desired, enter a new speed dial index.
4. Press **Save** to confirm or **Cancel** to abandon the change then press **Exit** to return to the idle display.

Idle display could now be as shown:

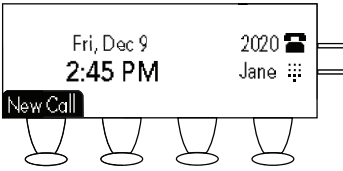

To dial a number assigned to a Line Key, simply press the line key directly opposite the number on the display.

*To quickly view a complete list of assigned speed dial entries, press  from the idle display. Dial directly from a selected number.*

---

## Multiple Lines

Your SoundPoint® IP 430 SIP can support up to two lines. Lines can be configured for private or shared lines.

Typically, the top-most line key is reserved for the principle directory number of the phone. Depending on how your phone is configured, the display could resemble one of the displays shown:

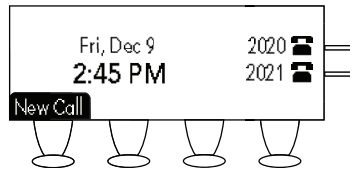
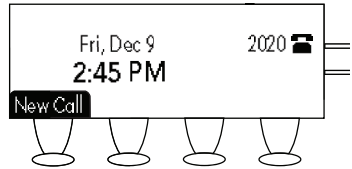

---

## Multiple Keys Per Line

A line on the phone can be configured to have both line keys associated with it. If this is the case, the display could look like this:

Incoming calls to this line will be distributed evenly among the two available keys. Similarly, outgoing calls will be distributed.

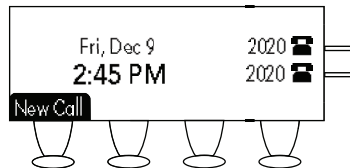

## Multiple Call Appearances

Each line on the phone can be configured to have one or more call appearances. More than one call appearance is useful if there is an active call and an incoming call arrives on the same line. In the example shown, extension 2020 is in an outbound call with 2024. The second figure shows an incoming call from John Brown. To answer this incoming call, put the original call on Hold or press the  key to access the new call. Soft key labels will be updated on the display with these options:

1. **Answer** the incoming call.
2. **Reject** the incoming call.
3. **Forward** the incoming call to another extension.

Answering the incoming call places the original call on Hold and refreshes the soft key labels as indicated (third figure). If more than one call appearance is in use, one will appear on the display and the total number will be indicated by a counter at the top right corner of the display. For example “2/3” indicates that the highlighted call is the second one out of a total of three.

In the example case illustrated, another outbound call can be placed on the same first line. Press **Hold** during the first call and press **NewCall** to obtain dial tone and a new call appearance for a second call.

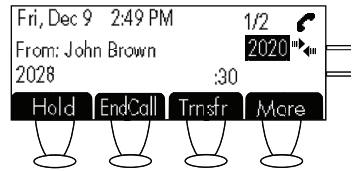
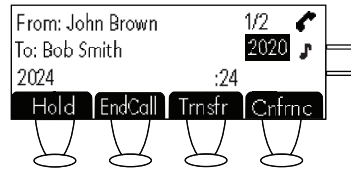
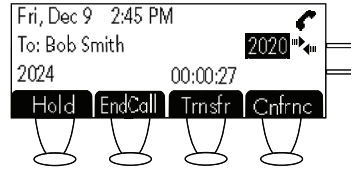

## Shared Lines

The phone supports shared lines \*\*. A shared line is indicated by a different line icon. In the figure, the first line is private and the second line is shared. If two phones share a line, an incoming call to that number will cause both phones to ring. The call can be answered on either phone but not both.

If a shared line is in use on one of the phones, it may be unavailable on the other one. The shared line icon changes to a moving icon and the line LED turns red when the line is in use remotely.

Calls on shared lines can be transferred, put on hold, or added to a conference.

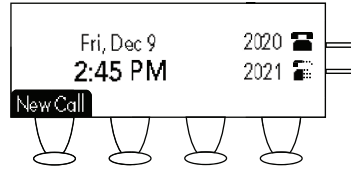

*\*\* Shared lines are an optional feature configured on the server and may not be supported on your particular system. Contact your system administrator to find out.*

## Voice Mail

Received messages will be indicated by a flashing Message Waiting Indicator LED on the front of the phone and optionally a visual notification on the display.

Individual line indicators reflect voice or text messages left on that line (useful if multiple lines are in use).

### To listen to voice messages:

1. Press **Messages** and select *Message Center* \*\*†.
2. (Optional) If multiple lines are in use, select from which line messages are to be retrieved.
3. Display indicates number of messages and their importance. Press

A stutter dial tone in place of normal dial tone is used to indicate that one or more voice messages are waiting at the message center.

**Connect** to initiate Voice Mail retrieval from the Message Center,

OR

Press **Clear** to turn off the flashing LED without listening to messages.

4. Follow voice prompts to listen to messages.

*\* Voice Mail is an optional feature configured on the server and may not be supported on your particular system. Contact your system administrator to find out.*

*† Screen options may vary with server-based application.*

*Voice Mail can be accessed with a single key press. Contact your system administrator to configure this option.*

## Distinctive Ringing / Call Treatment

You can set distinctive incoming ringing tones for contacts in your local directory. This allows identification of a contact by a specific ring tone.

### To set a distinctive ring for a local contact:

1. Press **Menu** then *Features*, and select *Contact Directory*.
2. Using the arrow keys, scroll through the directory to choose a contact.
3. Press **Edit** and scroll down to *Ring Type*.
4. Enter a number corresponding to one of the ring types available (press **▶** key and then **<<** to remove an

existing value). See **Ring Type** in this guide for further details.

5. Press the **Save** soft key or **Cancel** to abandon the change then **Menu** press to return to the idle display.

Incoming calls from this contact will now have a distinctive ringing pattern.

*This feature is local to the phone, and may be overridden by server settings. Contact your system administrator for more details.*

---

## Multilingual Support (Localization)

Many languages are supported by the phone.

### To change language:

1. Press **Menu** and select *Settings, Basic, Preferences, Language*.
2. Scroll through the list of available languages and press the **Select** soft key when the desired language is

highlighted.

3. The display will change to the language of your choice.
4. Exit to the idle display by pressing **Menu**.

## Phone Reboot

Periodically, the phone may require a user reboot. Reasons for this include accepting a new configuration or new software.

There are two ways to reboot the phone:

- ▶ Simultaneously press and hold the Messages, Hold, and Volume keys (see figure) for more than 3 seconds or until a beep is heard.
- ▶ Press **Menu** and select *Settings, Advanced, Restart Phone* (the user password is required to access this menu).

The reboot process will begin and is complete when the idle display is shown.

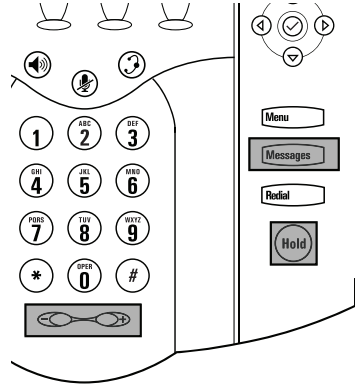

*In the case of problems, it may be possible to restore normal operation of your phone without rebooting. Contact your system administrator before attempting to reboot the phone.*

## Optional Features

### Text Messaging

You can send and receive Text messages on the phone. SIP Instant (Text) Messaging is supported in real-time. Received messages will be indicated by a flashing

Message Waiting Indicator LED on the front of the phone and optionally a visual notification on the display.

#### To read text messages:

1. Press **Messages** and select *Instant Messages*,  
OR  
Press the **IM** soft key to read a message just received.
2. (Optional) If multiple lines are in use, select from which line messages

- are to be retrieved.
3. Messages appear first to last in sent order.
4. Press the **Next** or **Prev** soft keys to cycle through messages in order.
5. Press the **More** soft key to access the **Delete**, **Reply** and **New** options.

### To send a text message:

1. Press **Messages**.
2. Select *Instant Messages*.
3. (Optional) If multiple lines are in use, first select from which line to send a message.
4. Press the **New** soft key.
5. Enter the desired extension or SIP URL. Press the **1/A/a** soft key to alternate between numeric and upper/lower case alphanumeric modes.
6. Press the **Select** soft key to choose

from various pre-scripted short messages,

OR

Press **Edit** to compose a custom message. Use dial pad keys to cycle through the character set. Use keys 1,\*,0, and # to select special characters.

7. Press **Send** when finished.

---

## Presence / Status / Buddy Lists

The phone combines interactive message services and status monitoring to complement a traditional messaging application such as email.

Live interaction within a pool of phones is possible by monitoring the “presence” of the parties involved.

Each phone can “watch” the status of up to eight other phones. These other phones form the “Buddy List”. The status of buddies is displayed and updated in real time. Each phone can also be “watched” by up to eight other phones.

### To add or delete a contact from your buddy list, or block a contact:

1. Press **Menu** and select *Features, Contact Directory*.
2. Using the arrow keys, scroll through the directory to choose a contact.
3. Press **Edit** and scroll down to the *Watch Buddy* or *Block Buddy* fields.
4. Press **▶** to switch between Enabled or Disabled status.
5. Press the **Save** soft key or **Cancel** to abandon the change then press **Menu** to return to the idle display.

The figures show a typical Buddy Status screen display of monitored phones and a My Status display.

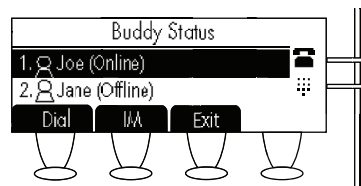
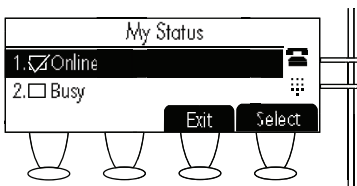



### To view and change Presence settings:

1. Press  and select *Features* and *Presence*.
2. Choose *My Status* to change your own status (online, busy, etc.). This affects information sent to watching phones. Presence information will also be sent to watching phones when the user goes off-hook or invokes Do Not Disturb. The *My Status* display can also be accessed by pressing the **Stats** soft key from the idle display.
3. Choose *Buddy Status* to monitor the status of the contacts within your buddy list. This can also be accessed by pressing the **Buddies** soft key on the idle display.
4. Choose *Watcher List* to see which phones are currently monitoring your status. Press the **Block** soft key to block a watcher.
5. Choose *Blocked List* to see which phones you have blocked from monitoring your status. Press the **Unblk** soft key to unblock a contact.

Your phone can be configured to work with Microsoft® Office Live Communications Server and communicate with others using Microsoft® Office Communicator and Windows Messenger. Contact your system administrator to find out.

### To add a contact in the buddy list:

1. Press the **Buddies** soft key on the idle display to get to the Buddy Status screen or press  and select *Features, Presence, Buddy Status*.
2. Press **More**.
3. Press **Add**.
4. Enter the number of the buddy, for example, 7778.
5. Press **Submit**.

If the buddy is added successfully, you are able to scroll to it on the Buddy Status screen.

Any contacts added through the buddy list will appear in as a contact in Microsoft® Office Communicator and Windows Messenger.

# Troubleshooting

## No Dial-Tone

Verify power is correctly applied to the SoundPoint® IP 430 SIP phone:

- Check that the display is illuminated.
- Make sure the LAN cable is inserted properly at the rear of the phone (try unplugging and re-inserting the cable).
- If using inline powering, check that the switch is supplying power to the phone (contact your System Administrator).

Verify if dial tone is present on any other audio paths:

- Switch between handset, headset (if present) or hands-free to see if dial tone is present on these other paths.
- If dial tone exists on one of these, connect a different handset or headset to isolate the problem.

## No Display, Incorrect Display, or Bad Contrast

Verify power is correctly applied to the SoundPoint® IP 430 SIP phone:

- As “No Dial-Tone” above.

Verify contrast adjustment:

- Follow the instructions in this User Guide to readjust the contrast to a darker level.
- Reboot the phone to obtain a default

display changes in response.

level of contrast (follow the instructions in this User Guide).

Verify successful outbound or inbound calling:

- Place a call to the phone under investigation - check that the display indicates incoming call information.
- Lift the handset. Ensure dial tone is present and place a call to another extension or number, check that the

## No Ringing

Verify incoming ring setting and volume levels:

- Adjust the ringing level from the front panel using the volume up/down keys.
- Check that ring type selection is not the hands-free speakerphone.

Silent Ring.

Verify successful outbound or inbound calling:

- As “No Display” above.
- Check same status of handset, headset (if connected) and through

## No Audio on Headset

Verify correct connections:

- Ensure the headset is plugged into the jack marked **Headset** at the rear of the phone.
- Ensure the headset amplifier (if pres-

ent) is turned on and/or the volume is correctly adjusted.

- Ensure that headset is compatible with the phone.

## No Response from Feature Key Presses

Verify phone is in active state:

- Make a call to the phone to check for inbound call display and ringing as normal. If successful, try to press feature keys within the call to access Directory or Buddy Status for example.
- Press Menu followed by System Status and Server Status to confirm line is actively registered to the server.
- Reboot the phone to attempt re-registration to the server.

## Display shows “Network Link is Down”

Verify LAN cable is properly connected:

- Check termination at the switch or hub (furthest end of the cable from the phone).
- Check that the switch or hub is operational (flashing link/status lights) or contact your System Administrator.
- Press  followed by *Status*, *Network* and *Ethernet*. Scroll down to verify LAN port is Active.
- Reboot the phone to attempt recon-

## Safety and Compliance

nection to the network.

### Part 15 Rules

This device complies with Part 15 of the FCC Rules. Operation is subject to the following two conditions:

ences received, including interference that may cause undesired operation.

### Class B Digital Device or Peripheral

Note: This equipment has been tested and found to comply with the limits for a Class B digital device, pursuant to Part 15 of the FCC Rules. These limits are designed to provide reasonable protection against harmful interference in a residential installation. This equipment generates, uses, and can radiate radio frequency energy and, if not installed and used in accordance with the instructions, may cause harmful interference to radio communications. However, there is no guarantee that

1. This device may not cause harmful interference, and
2. This device must accept any interfer-

ference will not occur in a particular installation. If this equipment does cause harmful interference to radio or television reception, which can be determined by turning the equipment off and on, the user is encouraged to try to correct the interference by one or more of the following measures:

1. Reorient or relocate the receiving antenna.
2. Increase the separation between the equipment and receiver.
3. Connect the equipment into an outlet on a circuit different from that to

which the receiver is connected.

4. Consult the dealer or an experience radio/TV technician for help.

Rules, the user is cautioned that any changes or modifications not expressly approved by Polycom, Inc. could void the user's authority to operate

Installation must be performed in accordance with all relevant national wiring rules.

*L'Installation doit être exécutée conformément à tous les règlements nationaux*

## Device

The socket outlet to which this apparatus is connected must be installed near the

*l'équipement et doit toujours être facilement accessible.*

## Industry Canada (IC)

## Modifications

In accordance with Part 15 of the FCC

the equipment.

## Installation Instructions

*applicable au filage électrique.*

## Plugs Acts as Disconnect

equipment and must always be readily accessible.

*La prise électrique à laquelle l'appareil est branché doit être installée près de*

This Class [B] digital apparatus complies with Canadian ICES-003.

*Cet appareil numérique de la classe [B]*

この装置は、情報処理装置等電波障害自主規制協議会（VCCI）の基準に基づくクラスB情報技術装置です。この装置は、家庭環境で使用することを目的としていますが、この装置がラジオやテレビジョン受信機に近接して使用されると、受信障害を引き起こすことがあります。  
取扱説明書に従って正しい取り扱いをして下さい。

## Polycom Limited Warranty and Limitation Liability

*est conforme à la norme NMB-003 du Canada.*

## CE and VCCI Mark

This SoundPoint® IP 430 SIP has been marked with the CE mark. This mark indicates compliance with EEC directories

89/336/EEC and 73/23/EEC.

A full copy of the Declaration of Conformity can be obtained from Polycom Ltd., 270 Bath Road, Slough, Berkshire, SL1 4DX, UK.

LIMITED WARRANTY. Polycom warrants to the end user (“Customer”) that this product will be free from defects in workmanship and materials, under normal use and service, for one year from the date of purchase from Polycom or its authorized reseller.

Polycom’s sole obligation under this express warranty shall be, at Polycom’s option and expense, to repair the defective product or part, deliver to Customer an equivalent product or part to replace

the defective item, or if neither of the two foregoing options are reasonably available, Polycom may, on its sole discretion, refund to Customer the purchase price paid for the defective product. All products that are replaced will become the property of Polycom. Replacement products or parts may be new or reconditioned. Polycom warrants any replaced or repaired product or part for ninety (90) days from shipment, or the remainder of the initial warranty period, whichever is longer.

## Exclusions

Products returned to Polycom must be sent prepaid and packaged appropriately for safe shipment, and it is recommended that they be insured or sent by a method that provides for tracking of the package. Responsibility for loss or damage does not transfer to Polycom until the returned item is received by Polycom. The repaired or replaced item will be shipped to the Customer, at Polycom’s expense, not later

than thirty (30) days after Polycom receives the defective product, and Polycom will retain risk of loss or damage until the item is delivered to the Customer.

Polycom will not be liable under this limited warranty if its testing and examination disclose that the alleged defect or malfunction in the product does not exist or results from:

## Warranty Exclusive

- Failure to follow Polycom’s installation, operation, or maintenance instructions.
- Unauthorized product modification or alteration.
- Unauthorized use of common carrier communication services accessed through the product.
- Abuse, misuse, negligent acts or omissions of Customer and persons under Customer’s control; or
- Acts of third parties, acts of God, accident, fire, lightning, power surges or outages, or other hazards.

IF A POLYCOM PRODUCT DOES NOT OPERATE AS WARRANTED ABOVE, CUSTOMER’S SOLE REMEDY FOR BREACH OF THAT WARRANTY SHALL BE REPAIR, REPLACEMENT, OR REFUND OF THE PURCHASE PRICE PAID, AT POLYCOM’S OPTION. TO THE FULL EXTENT ALLOWED BY LAW, THE FOREGOING WARRANTIES AND REMEDIES ARE EXCLUSIVE AND ARE IN LIEU OF ALL OTHER WARRANTIES, TERMS, OR CONDITIONS, EXPRESS OR IMPLIED, EITHER IN FACT OR BY OPERATION OF LAW, STATUTORY

## Service Agreements

OR OTHERWISE, INCLUDING WARRANTIES, TERMS, OR CONDITIONS OF MERCHANTABILITY, FITNESS FOR A PARTICULAR PURPOSE, SATISFAC-

## Limitations of Liability

TORY QUALITY, CORRESPONDENCE WITH DESCRIPTION, AND NON-INFRINGEMENT, ALL OF WHICH ARE EXPRESSLY DISCLAIMED. POLYCOM NEITHER ASSUMES NOR AUTHORIZES ANY OTHER PERSON TO ASSUME FOR IT ANY OTHER LIABILITY IN CONNECTION WITH THE SALE, INSTALLATION, MAINTENANCE OR USE OF ITS PRODUCTS.

Please contact your Polycom Authorized Reseller for information about service agreements applicable to your product.

LIMITATION OF LIABILITY. TO THE FULL EXTENT ALLOWED BY LAW, POLYCOM EXCLUDES FOR ITSELF AND ITS SUPPLIERS ANY LIABILITY, WHETHER BASED IN CONTRACT OR TORT (INCLUDING NEGLIGENCE), FOR INCIDENTAL, CONSEQUENTIAL, INDIRECT, SPECIAL, OR PUNITIVE DAMAGES OF ANY KIND, OR FOR LOSS OF REVENUE OR PROFITS, LOSS OF BUSINESS, LOSS OF INFORMATION OR DATA, OR OTHER FINANCIAL LOSS ARISING OUT OF OR IN CONNECTION WITH THE SALE, INSTALLATION, MAIN-

## Disclaimer

TENANCE, USE, PERFORMANCE, FAILURE, OR INTERRUPTION OF ITS PRODUCTS, EVEN IF POLYCOM OR ITS AUTHORIZED RESELLER HAS BEEN ADVISED OF THE POSSIBILITY OF SUCH DAMAGES, AND LIMITS ITS LIABILITY TO REPAIR,

REPLACEMENT, OR REFUND OF THE PURCHASE PRICE PAID, AT POLYCOM'S OPTION. THIS DISCLAIMER OF LIABILITY FOR DAMAGES WILL NOT BE AFFECTED IF ANY REMEDY PROVIDED HEREIN SHALL FAIL OF ITS ESSENTIAL PURPOSE.

## Governing Law

Some countries, states, or provinces do not allow the exclusion or limitation of implied warranties or the limitation of incidental or consequential damages for certain products supplied to consumers, or the limitation of liability for personal injury, so the above limitations and exclusions may be limited in their application to you. When the implied warranties are not allowed to be excluded in their entirety, they will be limited to the duration of the

applicable written warranty. This warranty gives you specific legal rights which may vary depending on local law.

This Limited Warranty and Limitation of Liability shall be governed by the laws of the State of California, U.S.A., and by the laws of the United States, excluding their conflicts of laws principles. The United Nations Convention on Contracts for the International Sale of Goods is hereby excluded in its entirety from application to this Limited Warranty and Limitation of Liability.

## Copyright Notice

All rights reserved under International and Pan-American Copyright Conventions.

No part of the contents of this manual may be copied, reproduced, or transmitted in

any form or by any means, or translated into another language or format, in whole or part, without written consent from Polycom, Inc.

Do not remove (or allow anybody else to remove) any product identification, copyright or other notices.

Polycom, the Polycom logo design, and SoundPoint are trademarks of Polycom, Inc. in the U.S. and various other countries.

Portions of the software contained in this product are Copyright (c) 1998, 1999, 2000 Thai Open Source Software Center Ltd. and Clark Cooper.

Permission is hereby granted, free of charge, to any person obtaining a copy of this software and associated documentation files (the "Software"), to deal in the Software without restriction, including without limitation the rights to use, copy, modify, merge, publish, distribute, sublicense, and/or sell copies of the Software, and to permit persons to whom the Software is furnished to do so, subject to the following conditions:

The above copyright notice and this permission notice shall be included in all copies or substantial portions of the Software.



**Polycom, Inc.**  
**4750 Willow Road**  
**Pleasanton, CA 94588-2708 USA**

©2007 Polycom, Inc. All Rights Reserved. Polycom®, SoundPoint®, and the Polycom logo design are registered trademarks of Polycom, Inc. in the U.S. and various countries. All other trademarks are the property of their respective companies.

1725-12439-001 Rev. D