



**USER GUIDE**

5.6.0 | July 2017 | 3725-46211-007A

---

# Polycom<sup>®</sup> VVX<sup>®</sup> Business Media Phones



Copyright© 2017, Polycom, Inc. All rights reserved. No part of this document may be reproduced, translated into another language or format, or transmitted in any form or by any means, electronic or mechanical, for any purpose, without the express written permission of Polycom, Inc.

6001 America Center Drive  
San Jose, CA 95002  
USA

**Trademarks** Polycom®, the Polycom logo and the names and marks associated with Polycom products are trademarks and/or service marks of Polycom, Inc. and are registered and/or common law marks in the United States and various other countries.



All other trademarks are property of their respective owners. No portion hereof may be reproduced or transmitted in any form or by any means, for any purpose other than the recipient's personal use, without the express written permission of Polycom.

**Disclaimer** While Polycom uses reasonable efforts to include accurate and up-to-date information in this document, Polycom makes no warranties or representations as to its accuracy. Polycom assumes no liability or responsibility for any typographical or other errors or omissions in the content of this document.

**Limitation of Liability** Polycom and/or its respective suppliers make no representations about the suitability of the information contained in this document for any purpose. Information is provided "as is" without warranty of any kind and is subject to change without notice. The entire risk arising out of its use remains with the recipient. In no event shall Polycom and/or its respective suppliers be liable for any direct, consequential, incidental, special, punitive or other damages whatsoever (including without limitation, damages for loss of business profits, business interruption, or loss of business information), even if Polycom has been advised of the possibility of such damages.

**End User License Agreement** BY USING THIS PRODUCT, YOU ARE AGREEING TO THE TERMS OF THE END USER LICENSE AGREEMENT (EULA) . IF YOU DO NOT AGREE TO THE TERMS OF THE EULA, DO NOT USE THE PRODUCT, AND YOU MAY RETURN IT IN THE ORIGINAL PACKAGING TO THE SELLER FROM WHOM YOU PURCHASED THE PRODUCT.

**Patent Information** The accompanying product may be protected by one or more U.S. and foreign patents and/or pending patent applications held by Polycom, Inc.

**Open Source Software Used in this Product** This product may contain open source software. You may receive the open source software from Polycom up to three (3) years after the distribution date of the applicable product or software at a charge not greater than the cost to Polycom of shipping or distributing the software to you. To receive software information, as well as the open source software code used in this product, contact Polycom by email at [OpenSourceVideo@polycom.com](mailto:OpenSourceVideo@polycom.com) (for video products) or [OpenSourceVoice@polycom.com](mailto:OpenSourceVoice@polycom.com) (for voice products).

**Customer Feedback** We are striving to improve our documentation quality and we appreciate your feedback. Email your opinions and comments to [DocumentationFeedback@polycom.com](mailto:DocumentationFeedback@polycom.com).

**Polycom Support** Visit the [Polycom Support Center](#) for End User License Agreements, software downloads, product documents, product licenses, troubleshooting tips, service requests, and more.

# Contents

---

<b>Before You Begin.....</b>	<b>10</b>
Audience, Purpose, and Required Skills.....	10
Related Documentation.....	10
<b>Getting Started with a VVX Business Media Phone.....</b>	<b>12</b>
Overview of Phone Hardware and Keys.....	12
VVX 101 and 201 Hardware.....	12
VVX 300 Series Hardware.....	14
VVX 400 Series Hardware.....	16
VVX 500 Series and VVX 600 Series Hardware.....	18
VVX 1500 Hardware.....	19
Securing Your Phone with the Security Slot.....	22
Navigating a VVX Business Media Phone.....	22
Accessing Screens on a VVX Business Media Phone.....	22
Switch Among Phone Screens.....	24
Icons and Status Indicators.....	25
Entering Information in Data Fields.....	32
Entering Information Using the Dial Pad.....	33
Enter Information Using the Onscreen Keyboard.....	33
Entering Chinese Characters with PinYin.....	34
<b>Logging Into and Locking Your Phone.....</b>	<b>37</b>
Logging Into a VVX Business Media Phone.....	37
Log In to a Phone.....	37
Log Out of the Phone.....	38
Change Your Login Password.....	38
Log In to a Visitor Desk Phone.....	38
Log Out of a Visitor Desk Phone.....	39
Log In to a Host Phone.....	39
Log Out of a Host Phone.....	39
Log In to a Guest ACD Phone.....	40
Log Out of a Guest ACD Phone.....	40
Sign In Using Your BroadSoft UC-One Credentials.....	40
Locking Your Phone.....	41
Lock Your Phone.....	41
Unlock the Phone.....	42
Change Your User Password.....	42

<b>Audio Calls.....</b>	<b>43</b>
Placing and Answering Audio Calls.....	43
Placing Audio Calls a VVX Business Media Phone.....	43
Redial a Number.....	48
Redial a Contact when the Contact is Available.....	48
Choosing a Protocol for Audio Calls.....	48
Answering Audio Calls.....	49
Switch Among the Handset, Headset, and Speakerphone.....	51
Mute and Unmute Audio.....	52
Holding and Resuming Calls.....	52
Hold a Call.....	52
Resume a Call.....	52
Resume a Call on a VVX Expansion Module.....	52
Ending Calls.....	53
End an Active Audio Call.....	53
End a Held Call.....	53
Transferring Calls.....	53
Choose a Default Transfer Type.....	53
Transfer a Call.....	54
Cancel a Transfer.....	54
Parking and Retrieving Calls on the BroadSoft BroadWorks Server.....	54
Park a BroadSoft Call.....	54
Retrieve a Parked BroadSoft Call.....	55
Retrieve a Parked BroadSoft Call on Another Phone.....	55
Ignore a Parked Call.....	56
Managing Calls.....	56
Display Calls from the Lines Screen.....	56
Display Calls from the Calls Screen.....	57
Manage a Call from the Calls Screen.....	57
Managing Calls on VVX 1500 Phones.....	57
View a List of Calls.....	58
Manage a Call.....	58
Managing Calls Remotely.....	59
Managing Calls with BroadSoft UC-One BroadWorks Anywhere.....	59
Managing Calls with BroadSoft UC-One Remote Office.....	61
Ignoring or Rejecting Incoming Calls.....	62
Ignore or Silence an Incoming Call.....	62
Reject Incoming Calls.....	62
Reject Calls from a Contact.....	62
Rejecting Calls with Do Not Disturb.....	63

Reject Anonymous Calls.....	64
Redirecting Incoming Calls.....	65
Forwarding Incoming Calls to a Contact.....	65
Divert Calls to a Contact.....	66
<b>Conference Calls.....</b>	<b>67</b>
Tips for Conference Calls.....	67
Audio Conference Calls.....	67
Initiate a Conference Call.....	67
Join Calls to Create a Conference Call.....	68
End a Conference Call.....	68
Hold a Conference Call.....	68
Resume a Conference Call.....	69
Split a Conference Call.....	69
Manage Conference Call Participants.....	69
Alcatel-Lucent Advanced Conference Calls.....	70
Initiate an Advanced Conference Call.....	70
Initiate an Advanced Conference Call During a Call.....	70
Add Contacts to an Advanced Conference Call.....	71
Join Calls to an Advanced Conference Call.....	71
Join Two Calls into an Advanced Conference Call.....	71
Viewing a Roster of Conference Participants.....	71
Managing Advanced Conference Participants.....	72
<b>Shared Lines.....</b>	<b>73</b>
Shared Line Limitations.....	73
Answering Calls on Shared Lines.....	73
Missed and Received Calls on Shared Lines.....	73
Hold a Call Privately on a Shared Line.....	74
Barge In on Calls for Busy Lamp Field Lines.....	74
GENBAND's Multiple Appearance Directory Number - Single Call Appearance.....	75
Placing a MADN Call.....	75
Answering a MADN Call.....	75
Barge In on an Active Call.....	75
Leave a Bridge Call.....	75
Resume a Held MADN Call.....	76
Enabling Privacy.....	76
Alcatel-Lucent Shared Call Appearance.....	77
Placing a SCAP Call.....	77
Answering a SCAP Call.....	77
Bridge In to an Active Call.....	78

Leave a Bridge SCAP Call.....	78
Make an Active Call Public.....	78
Make an Active Call Private.....	78
Holding or Passing Calls.....	79
BroadSoft UC-One Simultaneous Ring.....	79
Create a Personal Ring Group.....	80
Add Numbers to Your Simultaneous Ring List.....	80
Delete Numbers from the Simultaneous Ring List.....	80
BroadSoft Executive-Assistant.....	81
Filter Executive Calls.....	81
Filter Calls for an Executive.....	81
Screen Executive Calls.....	82
Enable Call Screening for an Executive.....	82
Answering Executive Calls.....	82
Place a Call on Behalf of an Executive.....	82
Pick Up a Held Executive Call on a Shared Line.....	82
Pick Up a Held Executive Call on a Shared Line.....	83
Pick Up a Held Executive Call on a Private Line.....	83
Barge In on an Executive Call.....	83
Silently Barge In on an Executive Call.....	83
Opt In or Opt Out of being an Assistant for an Executive.....	84
Divert Filtered Executive Calls.....	84
<b>Recording Audio Calls.....</b>	<b>85</b>
Guidelines when Recording Calls.....	85
Record a Call.....	86
Manage a Call while Recording.....	86
Pause a Recording.....	86
Resume a Recording.....	86
Stop Recording.....	86
Record a Conference Call.....	87
Browse Recorded Calls.....	87
Play a Recorded Call.....	87
Pause and Resume Played Recordings.....	88
Stop Playing a Recording.....	88
Rename a Recording.....	88
Delete a Recording.....	89
<b>Video Calls on VVX Business Media Phone.....</b>	<b>90</b>
Tips for Video Calls.....	90
Using a VVX Camera.....	91

Control the Lens Angle.....	91
Stop Sending Video with the Privacy Shutter.....	91
Status Indicators and Messages for the VVX Camera.....	92
Video Call Settings.....	93
Set the Call Rate for Video Calls.....	93
Stop Video for All Calls.....	93
Change Video Clarity.....	94
Changing the Video Call and Picture-In-Picture (PIP) Displays.....	94
Place a Video Call.....	97
Swap Video.....	97
Display Video Calls in Full Screen.....	97
Exit Full Screen View.....	98
Stop Sending Video.....	98
No Video from the Far Side.....	99
Handling Video and Audio Calls.....	99
Handle Conference Calls with Video.....	99
Managing Video Calls without a VVX Camera.....	100
View Video in Full Screen during Calls.....	100
Handling Video and Audio-Only Calls.....	101
Place Audio-Only Calls.....	101
<b>Call Lists and Directories.....</b>	<b>103</b>
Recent Calls.....	103
View Recent Calls.....	103
Sort Recent Call Entries.....	103
Sort Entries by Call Type.....	104
Edit a Recent Call Entry.....	104
Delete a Recent Call Entry.....	104
Save a Recent Call Entry.....	104
View Call Details.....	105
Contact Directory.....	105
Search for a Contact in the Contact Directory.....	105
Add a Contact to the Contact Directory.....	105
View Contact Information.....	106
Update a Contact's Information.....	106
Delete a Contact from the Contact Directory.....	107
Corporate Directory.....	107
Searching the Corporate Directory.....	107
Add Corporate Directory Contacts to the Contact Directory.....	108
BroadSoft Directories on a VVX Business Media Phone.....	108
View a List of BroadSoft Contacts.....	109

Searching the BroadSoft Directory.....	109
Add BroadSoft Contacts to the Contact Directory.....	110
Managing a Personal BroadSoft Directory.....	110
Managing the GENBAND Address Books.....	111
Using the Global Address Book.....	111
Using the Personal Address Book.....	113
<b>Favorites and Contact Lists.....</b>	<b>115</b>
Managing Favorites.....	115
Add Favorites.....	115
Viewing Favorites.....	115
Reorder Favorites.....	116
Delete Favorites.....	116
Using Buddy Lists.....	117
Add Contacts to Your Buddy List.....	117
View Your Buddy List.....	117
Monitor Contacts on Your Buddy List.....	117
View Your Watcher List.....	118
Block Contacts from Viewing Your Status.....	118
View a List of Blocked Contacts.....	118
Unblock a Contact.....	119
Managing BroadSoft UC-One Favorites and Contacts.....	119
BroadSoft UC-One Contacts' Presence Information.....	119
Viewing BroadSoft UC-One Contacts and Favorites.....	120
Filter BroadSoft UC-One Favorites.....	121
Search for BroadSoft UC-One Contacts.....	121
<b>Accessing, Sending, and Broadcasting Messages.....</b>	<b>122</b>
Accessing Voice and Video Messages.....	122
Access Voicemail and Video Messages.....	122
Remove the Message Alert.....	123
Instant Messaging.....	123
Send Instant Messages.....	123
Read Instant Messages.....	123
Reply to Instant Messages.....	124
Delete Instant Messages.....	124
Broadcasting Messages with Group Paging.....	124
Send a Group Page.....	124
Receiving Pages.....	125
Group Paging Settings.....	126
Broadcasting Messages with Push to Talk.....	127



Send a PTT Broadcast.....	127
Receiving PTT Broadcasts.....	128
Reply to PTT Broadcasts.....	129
End PTT Broadcasts.....	129
Push-To-Talk Settings.....	129
<b>Phone Applications.....</b>	<b>131</b>
Using the Calendar.....	131
Open the Calendar.....	131
Navigate to Other Views.....	131
Display Meeting View.....	132
Meeting Reminders.....	132
Joining Calendar Meetings.....	133
Navigating the Browsers.....	134
View the Idle Browser.....	134
Open the Web Browser.....	134
Using the Launch Pad on VVX 1500 Phones.....	135
Access the Launch Pad.....	135
Open Applications.....	136
Navigate the Launch Pad.....	136
Display the Launch Pad's Main Screen.....	136
Enable My Info Portal.....	136
<b>VVX Business Media Phone Settings.....</b>	<b>138</b>
Password Required to Access Basic Settings.....	138
Choose a Theme for Your Phone.....	138
Set the Language.....	139
Disable Call Waiting.....	139
Time and Date Display.....	140
Change the Time and Date Format.....	140
Disable the Time and Date Display.....	140
Backlight Intensity and Timeout.....	140
Set the Backlight Intensity.....	141
Set the Backlight Timeout.....	141
Changing Your Background.....	141
Change the Background Picture.....	142
Adding Personal Photos as Your Background.....	142
Reset Your Background.....	143
Customizing Line Keys.....	143
Customize the Columns on the Lines Screen.....	144
Enable Transparent Line Keys.....	144

Screen Savers.....	145
Enable Screen Savers.....	145
Use Personal Photos as Screen Savers.....	145
Disable the Screen Saver.....	146
Use Your Phone as a Digital Picture Frame.....	147
Picture Frame Icons.....	147
Power-Saving Mode.....	148
Change Your Office Hours.....	148
Change Timeouts.....	148
Changing Audio Settings.....	149
Change Incoming Call Notifications.....	149
Set a Ringtone for Incoming Calls.....	149
Set a Ringtone for Individual Contacts.....	150
Change the Volume.....	150
Updating Your Buddy Status.....	150
Update Your Buddy Status.....	150
Automatically Update Your Buddy Status.....	151
Security Classification.....	151
View the Security Classification for Your Phone.....	151
Modify Security Classification Level.....	151
<b>Phone Accessories and Computer Applications.....</b>	<b>153</b>
Using a Headset with Your Phone.....	153
Connecting a Headset.....	153
Use Your Headset for All Calls.....	154
Reactivate Headset Memory Mode.....	154
Using Electronic Hookswitch.....	154
Disconnect Your Headset.....	156
Using Bluetooth Headsets with VVX 600 Phones.....	156
Controlling Your Phone with Polycom Desktop Connector.....	158
Setting Up and Enabling the Polycom Desktop Connector.....	158
Using the Polycom Desktop Connector.....	161
Connecting a Netgear Wi-Fi Adapter to Your Phone.....	165
Connect the Wi-Fi Adapter.....	165
Connecting Polycom VVX Expansion Modules to Your Phone.....	166
VVX Expansion Module Hardware Features.....	166
VVX Color Expansion Module Hardware Features.....	167
Connect VVX Expansion Modules.....	169
Connect Additional Expansion Modules.....	169
Assigning Contacts and Favorites to VVX Expansion Modules.....	170
Generate the VVX Expansion Module Directory Card.....	171

Navigate VVX Color Expansion Module Paging.....	172
Changing the Backlight Intensity on VVX Expansion Modules.....	173
<b>Accessibility Features .....</b>	<b>174</b>
Features for Hearing-Impaired Users.....	174
Features for Mobility-Impaired Users.....	175
Features for Vision-Impaired and Blind Users.....	175
<b>Maintaining VVX Business Media Phone.....</b>	<b>177</b>
Investigate Warnings.....	177
Remove Warnings.....	177
Restart VVX Business Media Phone.....	178
Update the Configuration for VVX Business Media Phone.....	178
Test the Hardware.....	178
Clean the Touchscreen.....	179
View Software Details.....	179
Updating the Phone Software.....	180
Update the Phone Software.....	180
Update Software Later.....	180
Postpone Software Updates.....	180
Exit the Software Update Notification.....	180
<b>Troubleshooting.....</b>	<b>182</b>
Speakerphone.....	182
USB Port.....	182
Check the Status of the Calendar.....	182
GENBAND Address Book.....	183
View the Status of the Personal Address Book.....	183
Polycom Desktop Connector.....	183
Troubleshoot Audio and Echo Issues.....	184
Bluetooth Headset Issues.....	184
Recording Issues and Solutions.....	185

# Before You Begin

---

## Topics:

- [Audience, Purpose, and Required Skills](#)
- [Related Documentation](#)

This *Polycom® VVX® Business Media Phones User Guide* contains overview information for navigating and performing tasks on Polycom® VVX® business media phones.

This user guide contains information for the following Polycom® VVX® products:

- VVX 101 business media phones
- VVX 201 business media phones
- VVX 300, 301, 310, and 311 business media phones
- VVX 400, 401, 410, and 411 business media phones
- VVX 500 and 501 business media phones
- VVX 600 and 601 business media phones
- VVX 1500 business media phones
- VVX Camera
- VVX Expansion Modules

## Audience, Purpose, and Required Skills

This guide is intended for beginning users, as well as intermediate and advanced users, who want to learn more about the features available on a VVX Business Media Phone.

## Related Documentation

For additional information about Polycom VVX products, view the following support pages:

- [Polycom VVX 101](#)
- [Polycom VVX 201](#)
- [Polycom VVX 300 and 310](#)
- [Polycom VVX 301 and 311](#)
- [Polycom VVX 400 and 410](#)
- [Polycom VVX 401 and 411](#)
- [Polycom VVX 500](#)
- [Polycom VVX 501](#)
- [Polycom VVX 600](#)
- [Polycom VVX 601](#)
- [Polycom VVX 1500](#)
- [Polycom VVX Camera](#)

- [Polycom VVX Expansion Modules](#)

You can view the following types of documents on each product page:

- Quick Tips—A quick reference on how to use the phone's most basic features.
- Quick Start Guide—This guide describes the contents of your package, how to assemble the phone or accessory, and how to connect the phone to the network. The quick start guide is included in your phone package.
- Wallmount Instructions—This document provides detailed instructions for mounting your phone on the wall. To install your phone on the wall, you need the optional wallmount package, which includes the wallmount instructions.
- Administrator Guide—This guide provides detailed information about setting up your network and configuring features.
- Regulatory Notice—This guide provides information for all regulatory and safety guidance.

You can also view Feature Descriptions and Technical Notifications on the [Polycom Voice Support](#) page. These documents describe workarounds to existing issues and provide expanded descriptions and examples for phone settings and features. You can find these documents on the [Polycom Profiled UC Software Features](#) and [Polycom Engineering Advisories and Technical Notifications](#) support pages.

# Getting Started with a VVX Business Media Phone

---

## Topics:

- [Overview of Phone Hardware and Keys](#)
- [Navigating a VVX Business Media Phone](#)
- [Entering Information in Data Fields](#)

Before you use the phone, take a few moments to familiarize yourself with its features and user interface.

The terms “the phone” and “your phone” refer to any of the business media phones. Unless specifically noted in this guide, especially with regard to phone graphics, all VVX business media phones operate in similar ways.

---

**Note:** As you read this guide, keep in mind that certain features are configurable by your system administrator or determined by your network environment. As a result, some features may not be enabled or may operate differently on your device. Additionally, the examples and graphics in this guide may not directly reflect what is displayed or is available on your device screen.

---

## Overview of Phone Hardware and Keys

Use the following figures and tables to understand your VVX phone's hardware features. For more information about attaching phone hardware, including how to connect your phone to the network, see the *Quick Start Guide* for your phone available on your phone's support page on [Polycom Voice Support](#).

### VVX 101 and 201 Hardware

The following figure displays the hardware features on the VVX 101 and 201 business media phones. The table lists each feature numbered in the figure.

## VVX 101 and 201 hardware features

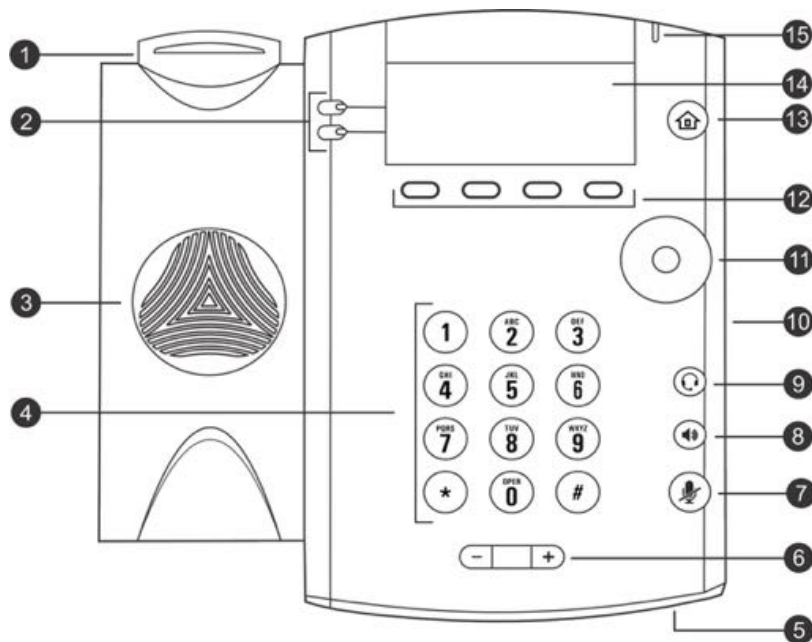

## VVX 101 and 201 Hardware Feature Descriptions

Reference Number	Feature	Feature Description
1	Hookswitch	Holds the handset and end calls.
2	Line keys	Enable you to select a phone line, view calls on a line, or quickly call a favorite contact.
3	Speaker	Provides ringer and speakerphone audio output.
4	Dialpad keys	Enable you to enter numbers, letters, and special characters. You can also use the dialpad keys to select menu items that have index numbers.
5	Microphone	Transmits audio to other phones.
6	Volume keys	Adjust the volume of the handset, headset, speaker, and ringer.
7	Mute key	Mutes local audio during calls and conferences.
8	Speakerphone key	Enables you to place and receive calls using the speakerphone.
9	Headset key	Enables you to place and receive calls through a headset.
10	Security slot (on side)	Enables you to attach a universal security cable lock to your phone so you can secure it to a desktop.

Reference Number	Feature	Feature Description
11	Navigation keys / Select key	Scrolls through information or options displayed on the phone's screen. Selects a field of displayed data.
12	Soft keys	Enable you to select context sensitive keys that display along the bottom of the screen.
13	Home key	Displays the Home screen from other screens, and displays the Lines and Calls screen from the Home screen.
14	Screen	Shows a 2.5-inch (6.35 cm) diagonal screen with a backlight that enables you to view menus and data. VVX 101 phones do not have a backlight.
15	Message Waiting Indicator	Flashes red to indicate when you have new messages.

## VVX 300 Series Hardware

The following figure displays the hardware features on the VVX 300, 301, 310, and 311 business media phones. The table lists each feature numbered in the figure.

### VVX 300 series hardware features

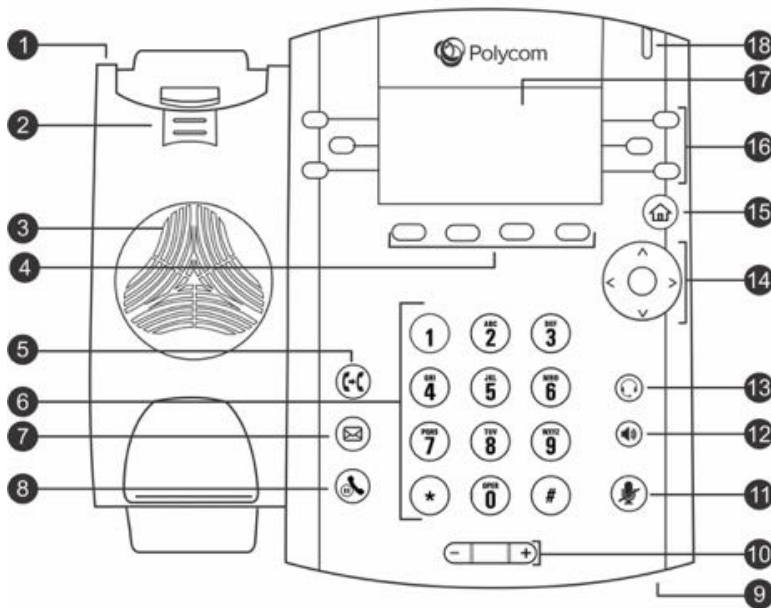



**VVX 300 Series Hardware Feature Descriptions**

<b>Reference Number</b>	<b>Feature</b>	<b>Feature Description</b>
1	Security slot (on top)	Enables you to attach a universal security cable lock to your phone so you can secure it to a desktop.
2	Reversible tab	Secures the handset in the cradle when your phone stand is positioned at a high angle. To secure the handset, remove the tab, reverse it so the protrusion points up, and re-insert it. Position the handset so the protrusion on the tab fits into the slot on the handset.
3	Speaker	Provides ringer and speakerphone audio output.
4	Soft keys	Enable you to select context sensitive keys that display along the bottom of the screen.
5	Transfer key	Transfers an active call to a contact.
6	Dialpad keys	Enable you to enter numbers, letters, and special characters. You can also use the dialpad keys to select menu items that have index numbers.
7	Messages key	Enables you to access and manage instant and voice messages.
8	Hold key	Holds an active call or resumes a held call.
9	Microphone	Transmits audio to other phones.
10	Volume keys	Adjust the volume of the handset, headset, speaker, and ringer.
11	Mute key	Mutes local audio during calls and conferences. The key glows red when activated.
12	Speakerphone key	Enables you to place and receive calls using the speakerphone. The key glows green when activated.
13	Headset key	Enables you to place and receive calls through a headset. The key glows green when an analog headset is activated, and blue when a USB or Bluetooth headset is activated.
14	Navigation key/ Select key	Scrolls through information or options displayed on the phone's screen. Selects a field of displayed data.
15	Home key	Displays the Home screen from other screens, and displays the Lines and Calls screen from the Home screen.
16	Line keys	Enable you to select a phone line, view calls on a line, or quickly call a favorite contact.
17	Screen	Shows a 3.2-inch (8.3 cm) diagonal screen with a backlight that enables you to view menus and data.

Reference Number	Feature	Feature Description
18	Message Waiting Indicator	Flashes red to indicate when you have new messages.

## VVX 400 Series Hardware

The following figure displays the hardware features on the VVX 400, 401, 410, and 411 business media phones. The table lists each feature numbered in the figure.

### VVX 400 series hardware features

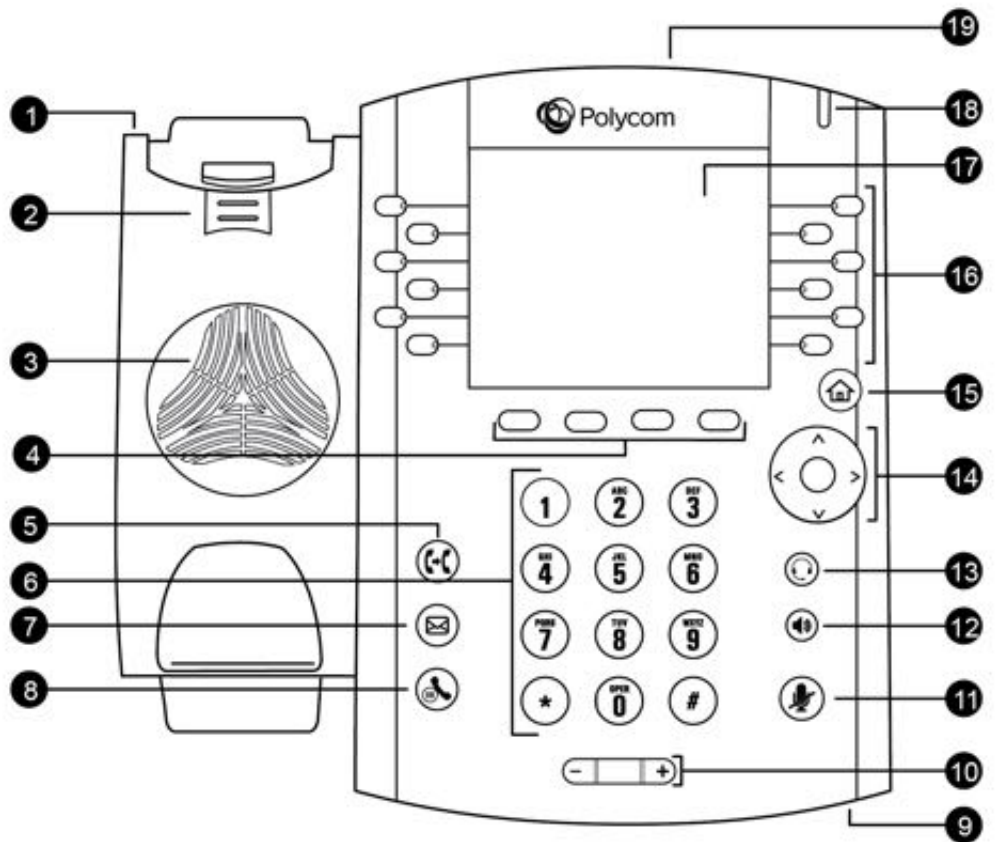

### VVX 400 Series Hardware Feature Descriptions

Reference Number	Feature	Feature Description
1	Security slot (on top)	Enables you to attach a universal security cable lock to your phone so you can secure it to a desktop.

Reference Number	Feature	Feature Description
2	Reversible tab	Secures the handset in the cradle when your phone stand is positioned at a high angle. To secure the handset, remove the tab, reverse it so the protrusion points up, and re-insert it. Position the handset so the protrusion on the tab fits into the slot on the handset.
3	Speaker	Provides ringer and speakerphone audio output.
4	Soft keys	Enable you to select context sensitive keys that display along the bottom of the screen.
5	Transfer key	Transfers an active call to a contact.
6	Dialpad keys	Enable you to enter numbers, letters, and special characters. You can also use the dialpad keys to select menu items that have index numbers.
7	Messages key	Enables you to access and manage instant and voice messages.
8	Hold key	Holds an active call or resumes a held call.
9	Microphone	Transmits audio to other phones.
10	Volume keys	Adjust the volume of the handset, headset, speaker, and ringer.
11	Mute key	Mutes local audio during calls and conferences. The key glows red when activated.
12	Speakerphone key	Enables you to place and receive calls using the speakerphone. The key glows green when activated.
13	Headset key	Enables you to place and receive calls through a headset. The key glows green when an analog headset is activated, and blue when a USB or Bluetooth headset is activated.
14	Navigation key/ Select key	Scrolls through information or options displayed on the phone's screen. Selects a field of displayed data.
15	Home key	Displays the Home screen from other screens, and displays the Lines and Calls screens from the Home screen.
16	Line keys	Enable you to select a phone line, view calls on a line, or quickly call a favorite contact.
17	Screen	Shows a 3.5-inch (8.89 cm) diagonal screen with a backlight that enables you to view menus and data.
18	Message Waiting Indicator	Flashes red to indicate when you have new messages.

Reference Number	Feature	Feature Description
19	USB Port	Enables you to attach a USB flash drive or USB headset (VVX 411 only).

## VVX 500 Series and VVX 600 Series Hardware

The following figure displays the hardware features on the VVX 500, 501, 600, and 601 business media phones. The table lists each feature numbered in the figure.

### VVX 500 series and VVX 600 series hardware features

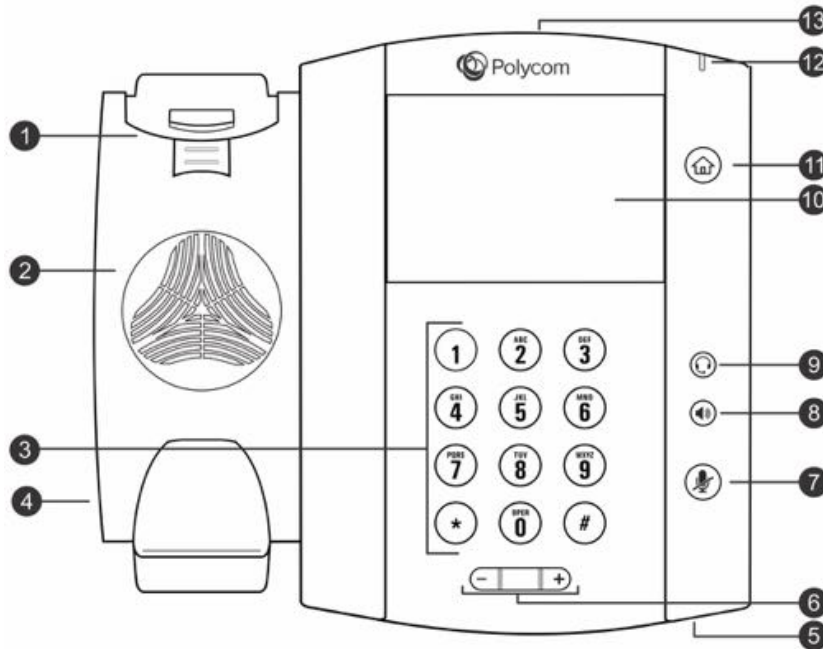

### VVX 500 Series and 600 Series Hardware Feature Descriptions

Reference Number	Feature	Feature Description
1	Reversible tab	Secures the handset in the cradle when your phone stand is positioned at a high angle. To secure the handset, remove the tab, reverse it so the protrusion points up, and re-insert it. Position the handset so the protrusion on the tab fits into the slot on the handset.
2	Speaker	Provides ringer and speakerphone audio output.
3	Dialpad keys	Enable you to enter numbers, letters, and special characters. You can also use the dialpad keys to select menu items that have index numbers.
4	Security slot (on side)	Enables you to attach a universal security cable lock to your phone so you can secure it to a desktop.

Reference Number	Feature	Feature Description
5	Microphone	Transmits audio to other phones.
6	Volume keys	Adjust the volume of the handset, headset, speaker, and ringer.
7	Mute key	Mutes local audio during calls and conferences. The key glows red when activated.
8	Speakerphone key	Enables you to place and receive calls using the speakerphone. The key glows green when activated.
9	Headset key	Enables you to place and receive calls through a headset. The key glows green when an analog headset is activated, and blue when a USB or Bluetooth headset is activated.
10	Touchscreen	Enables you to select items and navigate menus on the touch-sensitive screen. Tap the screen to select and highlight screen items. To scroll, touch the screen, and swipe your finger up, down, right, or left.
11	Home key	Displays the Home screen from other screens, and displays the Lines and Calls screens from the Home screen.
12	Message Waiting Indicator	Flashes red to indicate when you have new messages.
13	USB port	Enables you to attach a USB flash drive, a VVX Camera, or a USB headset.

## VVX 1500 Hardware

The following figure displays the hardware features on the VVX 1500 business media phone. The table lists each numbered feature shown in this figure.

## VVX 1500 hardware features

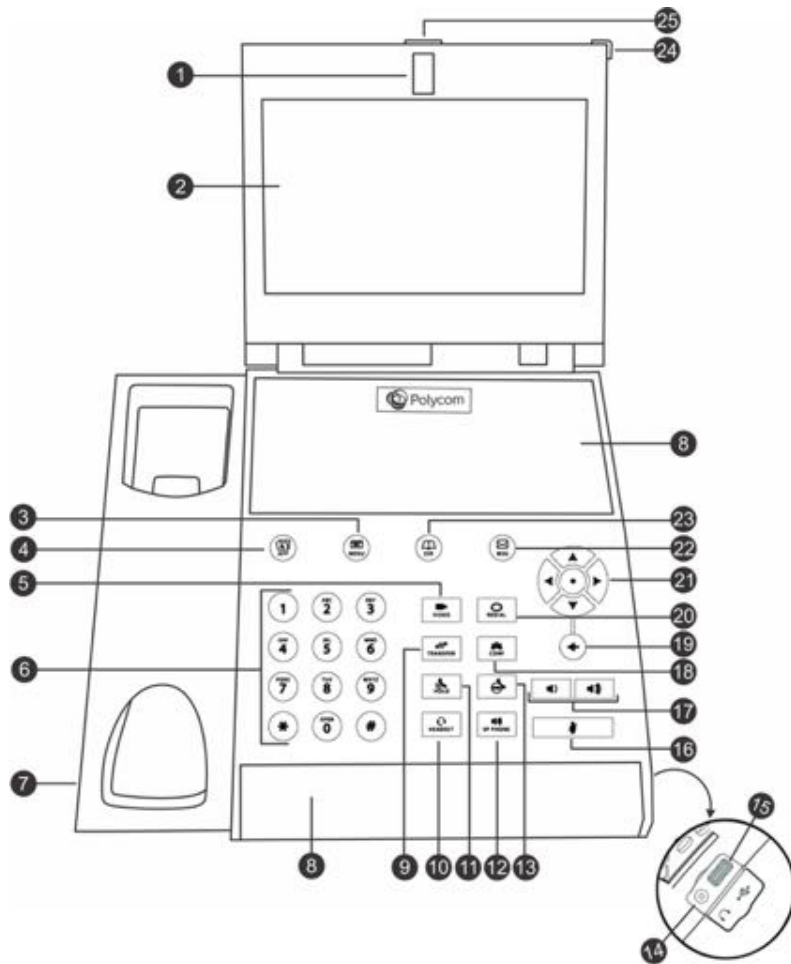

## VVX 1500 Hardware Feature Descriptions

Reference Number	Feature	Feature Description
1	Camera	Provides near-site video. The camera barrel is located directly behind the camera lens. The camera barrel adjusts the camera angle.
2	Touchscreen	Enables you to select items and navigate menus on the touch-sensitive screen. Tap the screen to select and highlight screen items. To scroll, touch the screen, and swipe your finger up and down.
3	Menu key	Enables you to access your phone and organization's features as well as other menu options.
4	Applications key	Enables you to access the Web Browser and Launch Pad.
5	Video key	Controls the size, position, and transmission of video images.

Reference Number	Feature	Feature Description
6	Dialpad keys	Enable you to enter numbers, letters, and special characters. You can also use the dialpad keys to select menu items that have index numbers.
7	Security slot (on side)	Enables you to attach a universal security cable lock to your phone so you can secure it to a desktop.
8	Speaker	Provides ringer and speakerphone audio output.
9	Transfer key	Transfers an active call to a contact.
10	Headset key	Enables you to place and receive calls through a headset. The key glows green when headset memory mode is enabled.
11	Hold key	Holds an active call or resumes a held call.
12	Speakerphone key	Enables you to place and answer calls using the speakerphone. The key glows green when the speakerphone is in use.
13	Do Not Disturb key	Cancels ringing and directs incoming calls to your mailbox. The key glows red when activated.
14	Headset connector	Enables you to connect a headset to the phone.
15	USB port	Enables you to connect a USB flash drive to display pictures on your phone, and to record and play back calls.
16	Mute key	Mutes your audio during calls and conferences. The key glows red when activated.
17	Volume keys	Adjust the volume of the handset, headset, speaker, and ringer.
18	Conference key	Enables connection with another party for a conference.
19	Delete key	Deletes data displayed on the screen.
20	Redial key	Dials your most recently called contact.
21	Arrow keys	Enable you to scroll through lists, highlight items, and scroll through active and inactive calls. The Left and Right arrow keys enable you to enable and disable fields, scroll through values for a field, and position the cursor within text to update the text. The Left arrow key also enables you to return to a previous menu.
22	Messages key	Enables you to access and manage instant, voice, and video messages.
23	Directory key	Enables you to access the Contact and Corporate directories, as well as call lists.

Reference Number	Feature	Feature Description
24	Message Waiting Indicator	Flashes red when you have new messages, when the phone is in power-saving mode, or when the software is loading on your phone.
25	Privacy Shutter	Covers and uncovers the camera.

## Securing Your Phone with the Security Slot

The security slot is located on the top, left, or right side of the phone and is indicated by a padlock  symbol. See the hardware figure for your phone for the location of the security slot.

By fastening one end of a universal security cable to a stationary object such as a desk or table, and the other end to the security slot available on VVX business media phones, you can prevent your phone from being removed. Refer to the universal security documentation for more information on securing your phone.

## Navigating a VVX Business Media Phone

The phone has icons, status indicators, and user screens to help you navigate and understand important information on the state of your phone.

### Accessing Screens on a VVX Business Media Phone

You can access the following screens on the phone:

- Home Screen—Displays your messages, settings, and information.
- Calls Screen—Displays all active and held calls on your line.
- Lines Screen—Displays your phone lines, favorites, and conditional soft keys.
- Active Call Screen—Displays the active call currently in progress.

### Access the Home Screen

On VVX phones, the phone lines and icons you can select to access phone features, settings, and information display on the Home screen. On VVX 1500 phones, your phone line and favorites display on the Home screen.

The following figure shows the Home screen on VVX 500 phones.

Home screen on VVX 500 phones





## Procedure

1. Press .

## Access the Calls Screen

The Calls screen is supported on VVX 101, 201, 300 series, 400 series, 500 series, and 600 series phones. You can access the Calls screen when you have one held call or an active and held call in progress on your phone.

The Calls screen is automatically displayed when you have an active call and one or more held calls on your phone. The total number of calls is displayed on your line, and if you have multiple lines on your phone, calls display under the associated line, as shown next.

### Calls screen on VVX 500 and 600 series phones

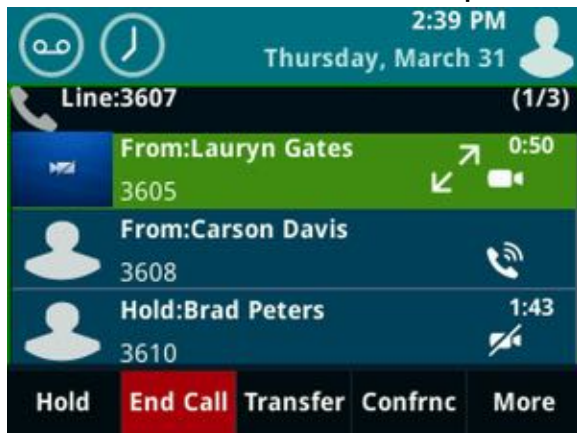

## Procedure

1. During a call, do one of the following:
  - Press the Home key .
  - On VVX 101 and 201 phones, press the L > C soft key.
  - On VVX 500/501 and 600/601 phones, tap **Return to Calls** in the status bar.
  - On VVX 500/501 and 600/601 phones, swipe the screen right to left.

## Access the Lines Screen

The Lines screen is supported on VVX 101, 201, 300 series, 400 series, 500 series, and 600 series phones and is the default screen when your phone is not in use. When you have multiple calls on your phone, the number of calls you have is displayed next to the line number.

You can view your phone lines, favorites, and soft keys on the Lines screen, as shown next.

### Phone line, favorites, and soft keys on the Lines screen on the VVX 300 series

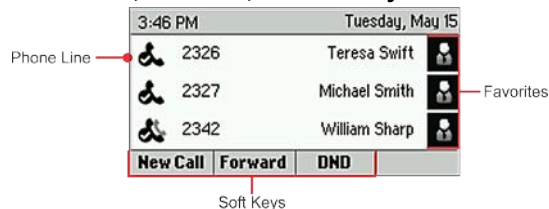

On VVX 500 and 600 series phone, you can also view active call and incoming call information in the status bar on the Lines screen, if enabled by your administrator, as shown next.

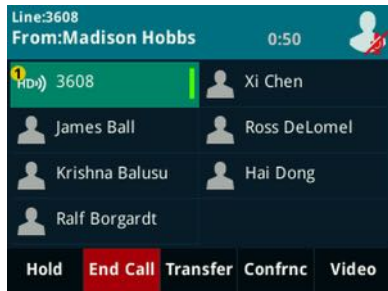

## Procedure

1. Press the Home key .

## Access the Active Call Screen

The Active Call screen is supported on VVX 1500, 500/501, and 600/601 phones, and the screen is displayed when you place a call and have an active call in progress. When you have an active call in progress, the name and number of the contact you are talking with and the duration of the call is displayed. In the Active Call screen, you can hold, end, and transfer the call, or set up a conference call.

### Active Call screen on VVX 500 series phones

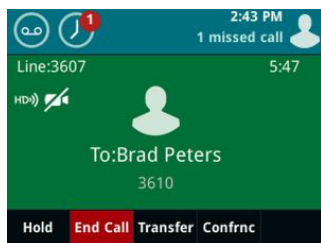

## Procedure

1. Do one of the following:
  - Place a call.
  - Press the Home key  during an active call.
  - Tap **Return to Calls** in the status bar.
  - Swipe the screen from right to left.

## Switch Among Phone Screens

You can see any phone screen on your phone from other screens by pressing the Home key , or by swiping your finger from right to left on the touchscreen. Although you can access any phone screen from other screens, you can access certain screens only if your phone is idle or has one or more calls in progress.



You can access certain screens in the following scenarios:

- If your phone is not in use, you can access the Home and Lines screen.
- If your phone has an active call, you can access all screens.

- If your phone has one active call only, you can access the Home, Lines, and Active Call screens.
- If your phone has multiple calls, or one held call, you can access the Home, Lines, and Calls screen.

On VVX 1500 phones, the Home screen is the default screen, and you can only view the Active Call screen when your phone has an active call in progress. There is no Home key on VVX 1500 phones, and you cannot switch among screens.

### Procedure









1. Do one of the following:
  - From the **Home** screen, press  to display either the Lines, Calls, or Active Call screen.
  - The Calls and Active Call screen display only when an active or held call is in progress on your phone.
  - Press the Home key  to display the Home screen from the Lines, Calls, or Active Call screen.
  - On VVX 101 and 201 phones, press the **C > L** soft key to display the Lines screen from the Calls screen.
  - On VVX 101 and 201 phones, press the **L > C** soft key to display the Calls screen from the Lines screen.
  - On VVX 500/501 and 600/601 phones, swipe the screen to the right or left to switch between the Lines, Calls, or Active Call screen.

















## Icons and Status Indicators

VVX business media phones have various icons and status indicators that inform you of the status of the phone whether you are in a call or the phone is idle and not in use.

The following table displays the phone icons and status indicators that display on the VVX 101 and VVX 201 business media phones.





**Icons and Status Indicators on VVX 101 and 201 Business Media Phones**



















Icon	Description	Icon	Description
	Registered line		Phone warning
	Unregistered line		Login credentials invalid
	Placing a call		Shared line
	Active call using Polycom HD Voice		Shared line with a held call

Icon	Description	Icon	Description
	Held call		Call forwarding is enabled
	Incoming call		New message
	Active conference		Presence status (Available)
	Placed call		Presence status (Busy or In a Call)
	Received call		Presence status (Away)
	Missed call		Presence status (Do Not Disturb)
	Favorite		Presence status (Offline)
	Do Not Disturb enabled		Presence status (Unknown)

### Icons and Status Indicators on VVX 300 Series Business Media Phones



























The following table displays the phone icons and status indicators that display on VVX 300 series business media phones.



Icon	Description	Icon	Description
	Registered line		Phone warning
	Unregistered line		Login credentials invalid

Icon	Description	Icon	Description
	Placing a call		Shared line
	Active call using Polycom HD Voice		Shared line with a held call
	Held call		Call forwarding is enabled
	Incoming call		New message
	Active conference		Presence status (Available)
	Placed call		Presence status (Busy or In a Call)
	Received call		Presence status (Away)
	Missed call		Presence status (Do Not Disturb)
	Favorite		Presence status (Offline)
	Do Not Disturb enabled		Presence status (Unknown)

### Icons and Status Indicators on VVX 400 Series Phones



















The following table displays the phone icons and status indicators that display on VVX 400 series business media phones.













Icon	Description	Icon	Description
	Registered line		Phone warning
	Unregistered line		Login credentials invalid
	Placing a call		Shared line
	Active call using Polycom HD Voice		Shared line with a held call
	Held call		Call forwarding is enabled
	Incoming call		New message
	Active conference		Presence status (Available)
	Placed call		Presence status (Busy or In a Call)
	Received call		Presence status (Away)
	Missed call		Presence status (Do Not Disturb)
	Favorite		Presence status (Offline)
	Do Not Disturb enabled		Presence status (Unknown)
	USB flash drive attached (VVX 401/411 only)		Recording paused (VVX 401/411 only)

Icon	Description	Icon	Description
	Recording in progress or paused (VVX 401/411 only)		Recording in progress (VVX 401/411 only)

### Icons and Status Indicators on VVX 500 Series and 600 Series Phones











The following table displays the phone icons and status indicators that display on VVX 500 series and VVX 600 series business media phones.

Icon	Description	Icon	Description
	Registered line		Status indicators in Lines screen. A flashing red bar indicates held calls. A green bar indicates an active call.
	Unregistered line		Do Not Disturb enabled
	Placing a call		Phone warning
	Active call using Polycom HD Voice		Login credentials invalid
	Held call		Shared line
	Incoming call		Call forwarding is enabled
	Active conference		Recent calls
	USB flash drive attached		USB flash drive in use
	Recording paused		Recording in progress

























Icon	Description	Icon	Description
	Placed call		Presence status (Available)
	Received call		Presence status (Busy)
	Missed call		Presence status (Away)
	Bluetooth available (VVX 600/601 only)		Presence status (Do Not Disturb)
	Bluetooth disconnected (VVX 600/601 only)		Presence status (Offline)
	New message		Presence status (Unknown)





### Icons and Status Indicators on VVX 1500 Business Media Phones

The following table displays the phone icons and status indicators that display on VVX 500 series and VVX 600 series business media phones.

Icon	Description	Icon	Description
	Line (registered, private)		Audio-only Call
	Line (registered, shared)		Audio Call with Polycom HD Voice
	Line (unregistered)		Video Call
	Buddy Status (Online)		Video Call with Polycom HD Voice
	Busy Lamp Field (BLF) indicator (line is idle)		



Icon	Description	Icon	Description
	Buddy Status (Busy, Do Not Disturb)		Call on hold (private line)
	Buddy Status (Be Right Back, Away, Out to Lunch)		Call on hold (shared line)
	Buddy Status (Offline)		Call without Polycom HD Voice (private line)
	Busy Lamp Field (BLF) indicator (line is busy)		
	New message		Call (shared line)
	Missed calls indicator		Conference call
	Audio muted		Do Not Disturb enabled
	Speed Dial Key		Forward (Always)
	USB device attached and idle		Headset attached
	USB device attached and playing back		Login credentials invalid
	USB device attached and recording		Video stopped and muted
	USB device attached and recording paused		Video stopped
	Presence status (Available)		Presence status (Do Not Disturb)

Icon	Description	Icon	Description
	Presence status (Busy)		Presence status (Offline)
	Presence status (Away)		Presence status (No information)

## Entering Information in Data Fields

You can enter information and edit fields using the dial pad keys on the phone console or using the onscreen keyboard on VVX 1500, 500/501, and 600/601 phones.

Before you enter information into fields, you can choose how to enter the information using the following soft keys:

- **Mode**—Enables you to enter just numbers or text in title case, lowercase, or uppercase characters.
- **Encoding**—Enables you to enter alphanumeric and special characters as well as characters in special languages.

The following table lists the Mode and Encoding options for the dial pad and the onscreen keyboard.

### Mode and Encoding Options

Mode Options	Encoding Options
Abc (to capitalize the first letter only, and use lowercase for the remaining letters)	Abc
ABC (to enter uppercase only)	ABC
abc (to enter lowercase only)	abc
123 (to enter numbers only)	123
	ASCII (for regular text)
	Latin (to enter accented characters)
	Katakana (for Japanese characters)
	Unicode (to store characters as double bytes)
	Cyrillic (for Russian characters)

When the onscreen keyboard is displayed, the Encoding and Mode soft keys are not available.

## Entering Information Using the Dial Pad

You can use the dial pad keys on your phone to edit or update field information. The following table describes how to enter different types of data on your phone using the dial pad.

### Using the Dial Pad Keys to Enter Information



Task	Action
Enter numbers, or characters in uppercase, lowercase, or title case mode	Select <b>Encoding</b> or <b>Mode</b> , and select <b>ABC,abc</b> , or <b>Abc</b> .
Enter only numbers	Select <b>Encoding</b> or <b>Mode</b> , and select <b>123</b> .
Enter text in another language	Select <b>Encoding</b> , and select one of the language options.
Enter a character	Press a dial pad key repeatedly to view the character options and stop when the character you want to enter is displayed in the field. Wait one second, and enter the next character.
Enter a number	Select <b>Encoding</b> or <b>Mode</b> , and select <b>123</b> , or press a dial pad key repeatedly to enter the number that displays on that key.
Enter a special character	Select <b>Encoding</b> , and select <b>Abc</b> , <b>ABC</b> , or <b>abc</b> . Press the <b>1</b> , <b>0</b> , <b>asterisk</b> , <b>*</b> , or <b>pound #</b> key one or more times to enter one of the following special characters: <ul style="list-style-type: none"> <li>• <b>1</b> key: !   ' ^ \ @ : 1</li> <li>• <b>*</b> key: * - &amp; % + ; ( )</li> <li>• <b>0</b> key: / , _ \$ ~ = ? 0</li> <li>• <b>#</b> key: # &gt; &lt; { } [ ] " ' `</li> </ul> <p>You cannot access special characters when you are in numerical (123) mode.</p>
Enter a space	Select <b>Encoding</b> , and select one of the alphabetic <b>Abc</b> , <b>ABC</b> , or <b>abc</b> . Press the <b>0</b> key. <p>You cannot enter a space when you are in numerical (123) mode.</p>
Delete one or more characters	Use the arrow keys to position the cursor to the right of the character, or drag your finger across the characters until the cursor is positioned to the right of the character(s) you want to delete. Press the <b>Delete</b> key, press the << soft key, or tap  .

## Enter Information Using the Onscreen Keyboard

The onscreen keyboard available on VVX 1500, 500 and 600 phones enables you to enter information into text fields using the touchscreen.



The onscreen keyboard displays on screen automatically when a text field is shown. When a text field requires only numbers, the onscreen keyboard displays only numbers.

## Procedure

1. Tap .
2. Tap  and select **Abc**, **ABC**, **abc**, **123**, or one of the special character options.
3. Press your finger on each character you want to enter.
4. When you finish, tap .

The following table describes how to enter information using the onscreen keyboard.

### Using the Onscreen Keyboard to Enter Information

Task	Action
Select an Encoding option (title case, uppercase, lowercase, numbers-only, ASCII, Latin, Katakana, Unicode, Cyrillic)	Tap  and select the Encoding options you want.
Enter text	Tap <b>Abc</b> and select the characters you want.
Enter uppercase characters	Tap <b>ABC</b> and select the characters you want.
Enter lowercase characters	Tap <b>abc</b> and select the characters you want.
Enter numbers	Tap <b>123</b> and select the numbers you want.
Enter special characters	Tap <b>ASCII</b> and select the characters you want.
Exit the onscreen keyboard, enter the information, and update the next field	Tap  .
Delete one or more characters	Drag your finger across the characters to highlight them in yellow then tap  .
Replace characters	Highlight the characters you want to replace then enter the new characters.

## Entering Chinese Characters with PinYin

PinYin is a commonly used method for inputting Chinese characters. The PinYin text input feature on VVX business media phones uses Nuance XT9<sup>®</sup> Smart Input to enable you to enter Chinese characters into text fields using the phone's dial pad keys or onscreen keyboard.

**Note:** For more information on the PinYin text input method, see the [Nuance's XT9 Smart Input](#) web site.

### Using the PinYin Input Widget

You can enter Chinese characters in the contact directory, corporate directory, and browser using the PinYin input widget and the dial pad keys or onscreen keyboard. When you select a data field to edit, the PinYin input widget is automatically displayed when Simplified or Traditional Chinese is set as the displayed language on your phone.

### PinYin input widget in the Contact Directory



### Enter Chinese Characters with the Dial Pad Keys

You can use the dial pad keys and the PinYin input widget to enter Chinese characters on your phone. The PinYin input widget disappears if you press the Pound key  or no keys are pressed for 5 seconds.



#### Procedure

1. Enter the PinYin text that corresponds with the letters on the phone's dial pad.  
For example, press 7464.  
The possible PinYin matches display in the text field with the first match highlighted.
2. Press the Star key  to toggle between selections.  
The recommendation area shows the possible character matches. A navigation indicator is displayed if more matches are available.
3. Use the left and right arrow keys or swipe the recommendation area on the touch screen to change the selected character.
4. Press the **Select** key to select the character from the recommendation area.
5. After the character is selected, it is displayed in the input field at the cursor location.
6. Repeat preceding steps until entry is complete.

### Enter Chinese Characters with the Onscreen Keyboard

You can use the onscreen keyboard and the PinYin input widget to enter Chinese characters on your phone.

#### Procedure

1. Tap .
2. Tap  to verify that PinYin is the default input mode.  
A list of language options display.
3. Ensure that **XT9 PinYin** is selected.
4. Enter the PinYin text using the onscreen keyboard.
5. Tap  on the onscreen keyboard to select the character from the recommendation area.

6. Repeat preceding steps until entry is complete.

# Logging Into and Locking Your Phone

---

## Topics:

- [Logging Into a VVX Business Media Phone](#)
- [Log In to a Visitor Desk Phone](#)
- [Log In to a Host Phone](#)
- [Log In to a Guest ACD Phone](#)
- [Sign In Using Your BroadSoft UC-One Credentials](#)
- [Locking Your Phone](#)

VVX business media phones enable you to log in to your phone with login credentials, sign into the phone with your BroadSoft UC-One credentials, or lock your phone.

## Logging Into a VVX Business Media Phone

You can log in to a phone and access your contacts or favorites, settings, and calendar, if enabled. Contact your system administrator for your user credentials.

If your system administrator has set up user credentials for your phone, you can view your personal settings from any phone or system within your organization.

---

**Note:** Some of the features described in this section require access to the Basic settings menu. If your phone requires a password to access the Basic settings menu, contact your system administrator for assistance.

---

## Log In to a Phone

Depending on how your system administrator set up the User Login feature, you may need to log in to a phone before you can use it.

By default, Polycom devices do not require you to log in before you can use them. However, if you do not log in, you see the default profile.

When you log in, you have full access to your personal settings and your directory. Any settings you change while logged into a public phone are saved and displayed the next time you log into your personal phone.

### Procedure

1. Do one of the following:
  - If you see the **User Login** screen, proceed to step 2.
  - If you do not see the **User Login** screen, navigate to **Settings > Features > User Login > Log In**.  
For VVX 1500 phones, select **Menu > Features > User Login > Log In**.
2. From the **User Login** screen, enter your user ID and password, and select **Log In**.

When your login credentials are accepted, your personal profile displays. If your credentials are not accepted, a message indicating your log in failed is displayed, and the User Login screen is displayed again. Check with your system administrator to confirm your login credentials.

## Log Out of the Phone

After you finish using a public phone, make sure you log out to prevent access to your personal settings.

### Procedure

1. Select **Log Out**, or navigate to **Settings > Features > User Login > Log Out**.  
For VVX 1500 phones, navigate to **Menu > Features > User Login > Log Out**.  
The Log Out screen is displayed with a confirmation message.
2. Select **Yes**.  
Your personal profile is no longer accessible, and either the User Login screen displays for the next user or the default profile displays.

## Change Your Login Password

You can change your login password from any phone on your network.

### Procedure

1. Log in to a phone on your network.
2. Navigate to **Settings > Features > User Login > Change User Login Password**.  
For VVX 1500 phones, select **Menu > Features > User Login > Log in Password**.
3. On the **Change User Login Password** screen, enter your old and new password information and select **Enter**.  
Your password is changed. The next time you log in to a phone, you need to enter your new password.

## Log In to a Visitor Desk Phone

When you are registered with the Alcatel-Lucent Converged Telephony Server (CTS), you can log into a visitor desk phone, which is a shared public phone, to make calls to contacts or access and change your personal settings.

When you log into a visitor desk phone, you have full access to your personal phone settings and your directory. After you log out, you can no longer view this information.

Your system administrator provides you with login credentials that you can use to log into a visitor desk phone. By default, Polycom phones do not require you to log in before you can use them. However, if you do not log in, you see only the phone's default profile.

This feature is not available for VVX 1500 phones. Check with your system administrator to find out if this feature is available on your phone.

### Procedure

1. Do one of the following:



- If you see the **Visitor Login** screen, proceed to step 2.
  - If you do not see the **Visitor Login** screen, press the **Visitor Login** soft key or navigate to **Settings > Features > Visitor Desk Phone > Visitor Login**.
2. From the **Visitor Login** screen, enter your user ID and password, and select **Log in**.
- When your login credentials are accepted, the phone updates to display your personal phone profile. When your credentials are not accepted, the message “User login failed” is displayed, and the Login screen is displayed again. Check with your system administrator to confirm that your login credentials are correct.

## Log Out of a Visitor Desk Phone

After you use a phone, make sure you log out to prevent access to your personal settings.

### Procedure

1. Select the **Log out** soft key, or navigate to **Settings > Features > Visitor Desk Phone > Visitor Log out**.

Your personal profile is no longer accessible, and the phone displays the default phone profile.

## Log In to a Host Phone

When you are registered with the BroadSoft BroadWorks server, and your administrator has enabled the Flexible Seating feature, you can log into your guest profile on a host phone, which is a shared, public phone, to place calls to emergency numbers as defined by your system administrator.

Your system administrator provides you with login credentials that you can use to log into a host phone.

When you log into a host phone, you have limited access to your personal phone settings and your directory. You can access the BroadSoft Directory and BroadSoft UC-One Favorites, but you cannot access your Contact Directory or general favorites from a host phone.

### Procedure

1. Do one of the following:
    - If you see the **Guest In** screen, proceed to step 2.
    - If you do not see the **Guest In** screen, press the **Guest In** soft key.
  2. From the **Guest In** screen, enter your username and password, and select **OK**.
- When your login credentials are accepted, the phone updates to display your personal phone profile. If your credentials are not accepted, a message indicating that your login credentials are invalid is displayed, and the phone displays the Lines screen. Check with your system administrator to confirm that your login credentials are correct.

## Log Out of a Host Phone

After you use a phone, make sure you log out to prevent unauthorized users from using your guest profile to place calls or from having access to your personal settings.

After you log out of the host phone, you can no longer view your guest profile information on the host phone, and you cannot view any changes or call history made on the host phone on your primary phone. If you are logged into your ACD account when you log out of the host phone, you are automatically logged out of your ACD account.

If your administrator has set a guest PIN for your account, you must enter your PIN to log out of a host phone.

If you do not sign out of a host phone after a designated time set by your system administrator, you are automatically logged out of the host phone.

#### Procedure

1. Select the **Guest Out** soft key.
2. If prompted, enter your guest PIN.

Your personal profile is no longer accessible, and the phone displays the default host profile.

## Log In to a Guest ACD Phone

If your system administrator has enabled Flexible Seating with the Automatic Call Distribution (ACD) feature, you can log in to your ACD account after you log in as a guest on a host phone.

If Hoteling is enabled, you do not need to log in as a guest before you can log in to your ACD account.

When you are logged into a guest ACD phone, you can answer incoming calls from call center customers, update your presence status, view incoming call center information, and transfer a call.

---

**Note:** When logging into a host phone as a guest user, the Use Host soft key is not available.

---

#### Procedure

1. Do one of the following:
  - If you see the **Agent Sign In** screen, proceed to step 2.
  - If you do not see the **Agent Sign In** screen, press the **ASignIn** soft key or navigate to **Settings > Features > Agent Sign In > Sign In**.

## Log Out of a Guest ACD Phone

After you use a phone, make sure you log out to prevent access to your personal settings.

#### Procedure

1. Select the **ASignOut** soft key, or navigate to **Settings > Features > Agent Sign In > Sign Out**.

The phone displays the default guest profile.

## Sign In Using Your BroadSoft UC-One Credentials

You can enter your BroadSoft UC-One credentials on your phone and register your line with the BroadWorks server.

Your system administrator provides you with your BroadSoft UC-One credentials.

This feature is not available for VVX 1500 phones. Check with your system administrator to find out if this feature is available on your phone.

## Procedure

1. Navigate to **Settings > Basic > UC-One Credentials**.
2. Enter the **Server Address**.
3. For **User**, enter the username for your account.
4. For **Password**, enter your password for your account.

## Locking Your Phone

Your system administrator provides you with a user password that you can use to unlock the phone.

Consider locking your phone if you want to:

- Prevent unauthorized outgoing calls.
- Allow only authorized people to answer calls.
- Prevent people from viewing or modifying phone information, such as your directory, call lists, or favorites.

When your phone is locked, you can:

- Place outgoing calls to emergency and authorized numbers only.
- Enter a password to answer incoming calls.
- View the browser, if enabled.

When your phone is locked, a message displays on the status bar informing you that the phone is locked and that only authorized calls are allowed. Any messages that displayed before the phone was locked do not display.

## Lock Your Phone

You can choose how you want your phone to handle incoming calls when it is locked. When you set up your phone to receive incoming calls when locked (the default setting), incoming calls ring on your phone, and you can answer calls by entering your user password.

When you set up your phone to ignore incoming calls, Do Not Disturb applies to all lines on your phone, and your phone does not ring.

---

**Note:** When the Flexible Seating feature is enabled, and you are logged in as a guest on a host phone, the Phone Lock feature is only available if your system administrator has set a 4 - 10 digit guest PIN for your user account. If you do not see the Lock soft key or menu option, check with your system administrator to see if this feature is available on your phone.

---

## Procedure

1. Select **Lock** or navigate to **Settings > Basic > Lock Phone**.  
For VVX 1500 phones, select **Menu > Settings > Basic > Lock Phone**.
2. From the **Lock Phone** screen, select **Allow ringing when locked** (the default setting) if you want your phone to ring when you have an incoming call.  
When you choose this option, you can answer a call by entering your user password or guest PIN.
3. Select **Lock**.

Your phone is locked.

---

**Tip:** You can quickly lock your phone by selecting the Lock soft key. When you do this, you cannot choose how to handle incoming calls. Your phone uses the default setting or the last setting selected.

---

## Unlock the Phone

Your system administrator provides you with a user password that you can use to unlock the phone.

### Procedure

1. Select **Unlock**.
2. Enter your user password, or guest PIN if signed in as a guest on a host phone and select **Unlock**.

## Change Your User Password

You can change your user password at any time from the Advanced settings menu, which requires a password. Ask your system administrator for the password to access the Advanced settings menu.

---

**Note:** You cannot change the user password or guest PIN on a host or visitor desk phone. If you need to change your user password, change the password on your personal phone. Ask your system administrator for help changing your guest PIN.

---

### Procedure

1. Navigate to **Settings > Advanced**.  
For VVX 1500 phones, navigate to **Menu > Settings > Advanced**.
2. Enter your user password and select **Enter**.
3. On the **Advanced** screen, select **Change User Password**.
4. On the **Change User Password** screen, enter your old and new password information and select **Enter**.

# Audio Calls

---

## Topics:

- [Placing and Answering Audio Calls](#)
- [Switch Among the Handset, Headset, and Speakerphone](#)
- [Mute and Unmute Audio](#)
- [Holding and Resuming Calls](#)
- [Ending Calls](#)
- [Transferring Calls](#)
- [Parking and Retrieving Calls on the BroadSoft BroadWorks Server](#)
- [Managing Calls](#)
- [Managing Calls on VVX 1500 Phones](#)
- [Managing Calls Remotely](#)
- [Ignoring or Rejecting Incoming Calls](#)
- [Redirecting Incoming Calls](#)

VVX business media phones enable you to place and answer SIP and H.323 calls, ignore incoming calls from all or individual contacts, and perform server-dependent tasks.

---

**Note:** Some of the features described in this section require access to the Basic settings menu on the phone. If your phone requires a password to access the Basic settings menu, contact your system administrator for assistance customizing your phone.

---

## Placing and Answering Audio Calls

VVX 101 and 201 phones can manage a maximum of eight active, incoming, and held audio calls at a time. VVX 300 series, 400 series, 500 series, 600 series, and 1500 phones can manage a maximum of 24 active, incoming, and held audio calls at a time. However, you can have only one active call in progress with numerous other incoming calls or calls on hold on all phones. Additionally, your system administrator can set up your phone to have up to six lines with unique extension numbers, or the same extension number as other lines on your network.

### Placing Audio Calls a VVX Business Media Phone

You can place calls on a phone in numerous ways, including international calls, calls from Recent Calls or directories, calls to contacts or favorites, calling a contact from a VVX Expansion Module, or calling authorized numbers on a locked phone.

### Call Charges for Outgoing Calls

If your service provider charges for outgoing calls, a notification displays on your phone informing you of the potential charges of an outgoing call. If enabled by your service provide, a tone plays on your phone

when call information displays. Check with your system administrator to find out if this feature is enabled for your phone.

The following call charge information displays on your phone for outgoing calls:

- **Call initiation costs**—the initial cost for placing a call.
- **Cumulative call costs**—the accruing cost of the ongoing call.
- **Completed call costs**—the total cost of the call after the call ends.

## Place a Call from the Dialer



The Dialer enables you to enter a number to place a call and displays a list of previously placed calls. As you enter numbers, the Dialer displays a list of similar numbers in your directory, and you can select a match to automatically enter the number.

---

**Note:** Your administrator can set up your phone to automatically place the call after you enter a certain number of digits. If a call is placed before you enter all the digits, add the number to your Contact Directory and dial the number from the Contact Information screen.

---

### Procedure

1. Do one of the following:
  - Start typing a phone number.
  - Select **New Call**.
  - Press a line key.
  - Pick up the handset, press , or press .
2. Enter a number or select a recent contact.
3. Select **Dial** or tap .

## Place an International Call

You can place calls to international phone numbers from the Dialer.

### Procedure

1. On the dial pad, quickly press the **star key** \* twice.  
A plus sign + is displayed.
2. Enter the remainder of the number and press **Dial** or tap .

## Place a Call from Recent Calls

You can place calls to contacts from the Recent Calls list, which contains calls that were recently placed, answered, or missed.

### Procedure

1. Do one of the following:
  - On VVX 101, 201, 300 series, and 400 series phones, navigate to **Directories > Recent Calls**.

- On VVX 500/501 and 600/601 phones, tap **Directories > Recent**.
  - On VVX 1500 phones, press the **Directory** key, and select **Call Lists**.
2. From the **Calls List** screen, select a contact and select **Dial**.  
On VVX 500/501 and 600/601 phones, the call is automatically placed after you select a contact.

## Calling Favorites

You can call your favorites from the Favorites list or by selecting a favorite on your Home or Lines screen. On VVX 1500 phones, you can call a favorite on the Home screen.

### Call Favorites from the Favorites List

When you add a contact as a favorite, the contact is added to your Favorites list, and you can call contacts directly from the Favorites list.

#### Procedure

1. Select **New Call**.
2. From the **Dialer**, select **Favorites**.
3. Select a favorite, and select **Dial**.

On VVX 500/501 and 600/601 phones, the call is automatically placed after you select a favorite.

### Call Favorites from the Home or Lines Screen

You can quickly call favorites from the Home or Lines screen.

#### Procedure

1. Do one of the following:
  - On VVX 101, 201, 300 series and 400 series phones, press a line key associated with a favorite on the Lines screen.
  - On VVX 500/501 and 600/601 phones, press , tap your phone line, and tap a favorite.
  - On VVX 1500 phones, tap a favorite.

A call is placed to the favorite automatically.

## Calling Contacts from the Directory

You can search for and call contacts in your Contact Directory, the Corporate Directory, and the BroadSoft Directory.

### Call a Contact from a Directory

You can place a call to a contact directly from your directory or you can select contacts in your directory to call from the New Call screen.

#### Procedure

1. Do one of the following:
  - Select **Directories**.
  - Navigate to **New Call > Directory**.

- On the VVX 1500, press the **Directory** key.
2. Choose a directory.
  3. From your directory, select or search for a contact.
  4. Select the contact's phone number.  
The call is automatically placed on VVX 500/501 and 600/601 phones.
  5. On VVX 101, 201, 300 series, 400 series, and 1500 phones, select **Dial**.

### Call a Contact from the Directory Search Screen

You can search for and call contacts from the Search screen in your directory.

#### Procedure

1. Select **Directories**.  
On VVX 1500 phones, press the **Directory** key.
2. Select **Search**, enter your contact's first or last name, and select **Search**.
3. Select your contact.
4. In the **Contact Information** screen, select the contact's number, and select **Dial**.

### Place a Call from a Locked Phone

When the phone is locked, you can place outgoing calls only to emergency numbers, such as 911, and authorized numbers that your administrator can set up. You cannot call any other numbers from a locked phone.

#### Procedure

1. Select **New Call**.
2. From the **Place an Authorized Call** screen, select a number, and select **Dial**.

### Placing Intercom Calls

The Intercom feature enables you to place a call to a contact that is answered automatically on the contact's phone as long as the contact is not in an active call. If the contact is in an active call, the contact can choose to answer the intercom call, or the intercom call is answered automatically after the active call ends.

Check with your system administrator to find out if this feature is available in your environment.

### Place an Intercom Call

You can place an intercom call to a contact to quickly relay a message.

#### Procedure

1. From the Home screen, select the **Intercom** icon or select the **Intercom** soft key.
2. Enter a number or select a contact.
3. Select **Dial** or tap .



The phone plays a tone and the call is answered automatically on the contact's phone.

4. Speak your message and wait for a response.
5. If you do not need to wait for a response, select **End Call** .

---

**Tip:** Your system administrator can set up your phone to automatically call a specific contact when you select Intercom. If your phone is set up this way, select Intercom and wait for your contact to answer before speaking your message.

---

## Place an Intercom Call During a Call

You can place an intercom call to another contact during an active call.

### Procedure

1. Select **Hold**, and select **Intercom**.  
The active call is placed on hold and the Dialer is displayed.
2. Enter a number or select a contact.
3. Select **Dial** or tap .
4. After the call is answered, speak your message and select **End Call Hang Up**.
5. Select **Resume**.

## Place a Call from a VVX Expansion Module

You can place a call using the line keys on your VVX Expansion Modules. Line keys on expansion modules activate available lines and place calls to contacts assigned to those lines.

### Procedure

1. Do one of the following:
  - Press a line key corresponding to an available line and dial the number.
  - Press the line key of the assigned favorite you want to call.

The call is placed and is displayed on your phone's screen.

## Place a Call with a Hidden Number

When your phone is registered with the BroadSoft BroadWorks server, you can choose to hide your phone number when you place a call.

Check with your system administrator to find out if this feature is available in your environment.

### Procedure

1. Select **UC-One** on the Home screen or navigate to **Settings > Features > UC-One Call Settings**.  
On VVX 1500 phones, navigate to **Menu > Features > UC-One Call Settings**.
2. If you have more than one line registered, select a line.
3. Select **Line ID Delivery Blocking** and select **Enabled**.  
Your number does not display when you place calls to contacts.

## Redial a Number

Your phone automatically keeps a record of all the calls placed, and you can recall the last contact you call using Redial.

### Procedure

1. Do one of the following:
  - Select **Redial** on the Home screen.
  - Press the **Redial** soft key.

## Redial a Contact when the Contact is Available

When you place a call to a contact, and the contact's line is unavailable due to an unregistered line or a service outage, a notification displays on your phone when the contact's line is available again. You can choose to redial the contact or dismiss the notification.

Check with your system administrator to find out if this feature is available on your phone.

### Procedure

1. When the contact availability notification displays, select **Dial**.

## Choosing a Protocol for Audio Calls

Your system administrator can set up your phone to handle calls that use the SIP protocol, the H.323 protocol, or both. Your system administrator can also set up your phone so that a line can handle one or both protocols, and enable you to choose the protocol you want to use before placing a call. Contact your system administrator to find out if calling with the H.323 protocol is enabled on your phone.

When your phone supports the H.323 protocol, the following limitations apply:

- You cannot forward or transfer H.323 calls.
- You cannot set up forwarding for lines that use the H.323 protocol only.
- You cannot set up shared lines on lines that use the H.323 protocol.
- You cannot place a call by just an H.323 name. You must use URL dialing using the following format: <H.323 name>@<server name>.

For dual-protocol phones, the protocol is displayed next to all call IDs, including the call IDs for conference call participants and calls on hold.

## Place an Audio Call using H.323

By default, your phone uses the SIP protocol, URL, to place audio calls. You can choose to use H.323 Protocol to place calls on VVX 1500, 500/501, and 600/601 phones.

### Procedure

1. Select **New Call**.
2. In the Dialer, tap **Use H.323** to place an H.323 call.  
H.323 is displayed in the number field. Your phone uses the H.323 protocol for all subsequent calls until you select a different protocol.
3. Enter your contact's H.323 URL name.

For example, `vvx500@100.100.100.100`.

## Set a Protocol for Placing Calls Automatically

Your system administrator can set up your phone so that you can enable it to automatically select the protocol to use for all calls.

When you place calls from call lists or directories, your phone automatically chooses the protocol to use based on the information in the call list or directory. When you add a contact to your Contact Directory, you can specify the protocol the contact uses to handle calls. This enables your phone to automatically use the correct protocol when you dial the contact.

### Procedure

1. Tap **New Call**.
2. In the Dialer, tap **Use Auto** to enable your phone to automatically select the protocol to use.  
Your phone uses the selected protocol for all subsequent calls until you select a different protocol.

## Answering Audio Calls

When you receive an incoming call, you can choose to answer the call in various ways, including answering calls in the Incoming Calls screen, in the Calls screen, during a call, and automatically.

### Answer an Incoming Call

When you receive an incoming call, the phone rings and an Incoming Call screen is displayed, as shown next. In the Incoming Call screen, you can choose to answer or reject the incoming call.

#### Incoming Call window





---

**Note:** Your system administrator can enable the screen to flash bright orange when you have an incoming call. The screen continues to flash until the incoming call is displayed in the Home or Calls screen. For more information about this feature, contact your system administrator.

---

### Procedure

1. Do one of the following:
  - Pick up the handset.
  - Press  or select **Answer**.

- Press .

After you answer the incoming call, the call becomes active.

## Answer a Call from the Calls Screen

When you don't answer an incoming call within 10 seconds, the Incoming Call screen disappears, and the Calls screen is displayed.

### Procedure

1. Select the incoming call, and select **Answer**.

If your phone is locked, you must enter a user password or PIN before answering the call.

## Answer a Call When in a Call

When you are in an active call and an incoming call arrives on the same or a different line, a call waiting tone beeps, and the Incoming Call screen is displayed.

If you don't answer the call within 10 seconds, the Incoming Call screen disappears, and the Calls screen is displayed.

### Procedure

1. Select **Answer**.

The active call is placed on hold, and the incoming call becomes active.

## Answer Calls Automatically

You can set up the phone to automatically answer calls using the Auto Answer feature. When enabled, the phone automatically answers all incoming calls using the speakerphone. Your system administrator sets how many times the phone rings before the call is automatically answered.

When Auto Answer is enabled and you receive an incoming call while in a call, the incoming call is not answered until you end or hold the current call.

### Procedure

1. Navigate to **Settings > Basic > Preferences**.  
On VVX 1500 phones, navigate to **Menu > Settings > Basic > Preferences**.
2. Select **Auto Answer**.
3. Select **Auto Answer SIP Calls** and select **Yes**.
4. If your phone supports H.323 protocol, select **Auto Answer H.323 Calls** and select **Yes**.  
This option is displayed only if your phone supports the H.323 protocol.
5. Select **Microphone Mute** and choose **Yes** (the default setting) to mute the microphone for auto-answered calls.
6. Select **Video Mute** and select **Yes** to mute the video when video calls are auto-answered.
7. Select **Save**.

## Answer a Call on a Locked Phone

When you set up the phone so that you can answer incoming calls when it is locked, you can answer calls by entering a user password.

### Procedure

1. On the Incoming Call screen, select **Answer**.
2. Enter your user password or guest PIN and select **Enter**.  
The call connects.

## Answer an Intercom Call

When you receive an intercom call, the call is answered automatically using the speakerphone.

You can switch to the handset or headset after the call is answered.

If the phone is set up to answer intercom calls with your microphone muted, you need to unmute your microphone before responding to the call.

### Procedure

1. After the call is answered, press  **Mute** and reply.

## Answer a Call from a VVX Expansion Module



You can answer calls using the line keys on your VVX phone or from your VVX Expansion Module.

### Procedure





1. Press the expansion module line key with a flashing green LED indicator.

# Switch Among the Handset, Headset, and Speakerphone

You can place and answer calls on your phone using the handset, headset, or speakerphone, and you can alternate among the three modes during calls, if available.

When using the speakerphone, the Speakerphone key  glows green. When using the headset, the Headset key  glows green if an analog headset is connected or blue if a USB headset is connected. For VVX 101 and 201 phones, the headset and speakerphone keys do not glow and the Headset  icon displays in the status bar.



### Procedure

1. During a call, pick up the handset, press the Headset key  or press the Speakerphone key .  
For example, if you're using the handset, press the Headset key  to switch to the headset, or press the Speakerphone key  to switch to the speakerphone.

## Mute and Unmute Audio

You can mute the microphone so other parties cannot hear you. Microphone Mute applies to the handset, headset, and speakerphone. You can still hear all other parties when you mute your microphone. When your audio is muted, the Mute icon is displayed, and the Mute key glows red, excluding VVX 101 and 201 phones.

### Procedure

1. During a call, including a conference call, press . The other parties cannot hear you.
2. Press  again to unmute the microphone.

## Holding and Resuming Calls

When you are in a call, you can place an active audio call on hold and resume the call.

### Hold a Call

You can place any active call on hold.

#### Procedure

1. During an active call, select **Hold**. If you're in the Calls screen, select the call first. A hold icon  is displayed on the line of the held call, and a red LED light flashes on the line key for all phones except VVX 101 and 201 phones.

### Resume a Call

You can view and resume all held calls in the Active Call and Calls screens.

#### Procedure

1. Do one of the following:
  - Select **Resume**.
  - From the Calls screen, select the call, and select **Resume**.

### Resume a Call on a VVX Expansion Module

You can resume calls placed on hold by other contacts from your VVX Expansion Module. A flashing red LED light on a line key on the expansion module indicates a call is on hold on the contact's line.

#### Procedure

1. Press the line key corresponding to the line with the held call.

## Ending Calls

You can end active calls at any time, however, you must resume held calls before you can end the call.

### End an Active Audio Call

You can end an active call on your phone at any time.

#### Procedure

1. Do one of the following:
  - Place the handset on the cradle.
  - Press **End Call**.
  - In the Calls screen, highlight the call and press **End Call**.

### End a Held Call

You cannot end calls that are on hold. You must resume held calls before ending them.

#### Procedure

1. From the Calls screen, select the held call and press **Resume > End Call**.

## Transferring Calls

You can transfer active or held calls to another person using the following transfer types:

- Blind transfer—Transfers the call directly to another line without speaking with the other party first.
- Consultative transfer—Enables you to speak with the other party before completing the transfer.

### Choose a Default Transfer Type

You can choose a default transfer type to use for all calls.

When you choose a default transfer type, and the phone uses the set transfer type for all calls. Consultative is set as the transfer type by default.

#### Procedure

1. Navigate to **Settings > Basic > Preferences**.  
On VVX 1500 phones, navigate to **Menu > Settings > Basic > Preferences**.
2. Select **Default Transfer Type** and choose a transfer type.  
The selected transfer type is used for all calls.

## Transfer a Call

You can transfer a call to another contact and choose the transfer type you want to use for the call.

### Procedure

1. During a call, do one of the following
  - Press **Transfer** to use the default transfer type.
  - Press and hold **Transfer** to use the non-default transfer type.  
For example, if Blind is the default, press and hold Transfer to perform a Consultative transfer.
  - Press **Transfer > More**, and select **Blind** or **Consultative**.  
Depending on the default transfer type, either the Blind or Consultative option displays. For example, if the default transfer type is Blind, then you can select Consultative.
2. Dial a number or choose a contact from the Recent Calls or a directory.  
If the transfer type is set to Blind, the call is transferred immediately.
3. If the transfer type is set to Consultative, select **Transfer** after speaking with your contact.

## Cancel a Transfer

If a contact does not answer the transfer or you want to remain speaking with the contact on your line, you can cancel the transfer before it is complete.

### Procedure

1. Select **Cancel**.  
The call is not transferred and becomes active.

## Parking and Retrieving Calls on the BroadSoft BroadWorks Server

When your phone is registered with a BroadSoft BroadWorks server, you can use Call Park to park a call directly to a contact's line. Call Park is different from call hold in that the call is parked on another contact's line, which enables you to continue using your phone to place other calls. Call Park is also available for shared lines. Check with your system administrator to find out if this feature is available on your phone.

### Park a BroadSoft Call

You can park a call directly on a contact's line. When you park a call on a contact's line, the call is removed from your phone, and the contact is notified that a call is parked on his or her line.

When a contact sends a parked call to your extension, the following notifications are displayed or played on your phone:

- The Call Park icon (P).
- The message "Call is parked" in the status bar.



- An audio notification plays, if enabled by your administrator. Audio notifications are not available for BLF monitored contacts.

The Call Park icon (P) also displays for shared lines, monitored contacts, and for lines and monitored contacts on VVX Color Expansion Modules.

### Procedure

1. During a call, press **Hold** and dial **\*68** and the contact's line extension.  
For example, dial \*684144.

## Retrieve a Parked BroadSoft Call

When a contact parks a call on your line, the status message and the Call Park icon display on your phone until the parked call is either retrieved, ignored, or the parked caller ends the call.

If a parked call is not answered after a period of time, which is set by your system administrator, the call is returned to the parker—the person who parked the call. If the parker answers the returned call, the parked call is removed from the parked extension. If the parker rejects the returned call, the parked call remains on the parked extension until the call is returned to the parker and answered, or the parked caller ends the call.

### Procedure

1. Press and hold the line key with the parked call.  
The **Park Info** soft key is displayed.
2. Press the **Park Info** soft key.  
The **Parked Call** screen is displayed, as shown next.



3. Press **Retrieve**.

## Retrieve a Parked BroadSoft Call on Another Phone

You can also retrieve a parked call from any phone within your network.

When a parked call is retrieved by a contact monitoring your line, the Call Park icon (P) and status message is removed from the line.

## Procedure

1. Press **New Call** and dial **\*88** and the extension the call was parked on.  
For example, dial **\*884144**.

## Ignore a Parked Call

You can choose to ignore a parked call instead of retrieving the call. Ignoring the parked call removes the parked call icon, but the call remains parked on your line until the call is retrieved, the retrieval time expires, or the call is ended.

## Procedure

1. Press and hold the line key with the parked call.  
The **Park Info** soft key is displayed.
2. Press the **Park Info** soft key.  
The **Parked Call** screen is displayed.
3. Press **Ignore**.  
The phone exits the Parked Call screen, and the Call Park icon (Ⓟ) and status message is removed from the line.

## Managing Calls

On VVX 101, 201, 300 series, 400 series, 500 series, and 600 series phones, you can see the number of calls on the line from the Lines screen, as shown next. On all VVX business media phones, a green light on the line key indicates a line with an active call, and a red light indicates a line with one or more held calls.

### Multiple Calls on phone lines on the Lines screen

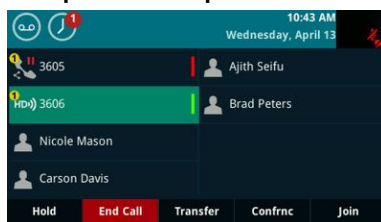

## Display Calls from the Lines Screen

You can display the calls for each line from the Lines screen.

When you select a phone line that does not have an active call, the first held call on that line is automatically resumed, even if you already have an active call on a different line.

## Procedure

1. Do one of the following:
  - Press and hold the line key.
  - Tap and hold the phone line.

- On VVX 500/501 and 600/601 phones, swipe the screen from right to left.

## Display Calls from the Calls Screen

You can also view multiple calls on your line from the Calls screen.

### Procedure

1. Do one of the following:
  - On VVX 101 and 201 phones, press the **L > C** soft key.
  - From the **Lines** or **Home** screen, press .
  - On VVX 500/501 and 600/601 phones, tap **Return to Calls** in the status bar.

The Calls screen is displayed with the list of active and held calls for each line on the phone.

## Manage a Call from the Calls Screen

From the Calls screen, you can manage a call by holding, resuming, or transferring the call.

### Procedure

1. Select a call.
2. Do one of the following:
  - Select **Hold** to place an active call on hold.
  - Select **Resume** to make a held call active.
  - Select **End Call** to end a call with a contact. You can end active calls only, so resume the held call first before ending it.
  - Select  **Transfer** to send the call to another contact.
  - Select **Conference** to initiate a conference call.

## Managing Calls on VVX 1500 Phones

When you have active and held calls on VVX 1500 phones, your phone displays the number of calls next to the line key. If you have an active call and numerous held calls on a line, the Active Call screen is displayed and a list of held calls is displayed above the soft keys, as shown next. If you have only held calls on your line, the Active Call screen does not display.

### Active and held calls on a VVX 1500 phone



A green bar on the line key indicates the line has an active call, and a flashing red bar indicates the line has one or more held calls.

## View a List of Calls

Your phone displays only the list of calls for one line at a time. If you have multiple lines on your phone, you have to select the line to view calls on that particular line.

### Procedure

1. Tap the line.

The line key glows green, and a list of held calls is displayed above the soft keys. The first held call on the line is automatically resumed.

## Manage a Call

You can manage a call by holding, resuming, or transferring the call, or you can initiate a conference. When you have more than three held calls on a line, you can press the left and right arrow keys to display the remaining held calls.

### Procedure

1. Tap the line with the held calls.

The first held call on the line is automatically resumed.

2. Tap  or use the right arrow key to view additional held calls.

3. Tap a held call.

4. Do one of the following:

- Tap **Hold** or press the **Hold** key to place an active call on hold.
- Tap **Resume** or press the **Hold** key.
- Tap **End Call** to end a call with a contact. You can end active calls only, so resume the held call first before ending it.
- Tap **Transfer** to send the call to another contact.
- Tap **Conference** to initiate a conference call.

## Managing Calls Remotely

When your phone is registered with a BroadWorks server, and you are signed in to the phone with your BroadSoft UC-One credentials, you can manage calls to your line remotely from any of your phones using the BroadWorks Anywhere or Remote Office features. With these features, you can handle any incoming calls to your office phone on other phones or mobile devices, and move calls seamlessly from your mobile device to your desk phone without ending the call.

Check with your system administrator to find out if these features are available on your phone.

## Managing Calls with BroadSoft UC-One BroadWorks Anywhere

BroadWorks Anywhere is a BroadSoft UC-One feature that enables you to use one phone number to receive calls on your desk phone, mobile phone, or home office phone and place calls from any of these phones using one number.

BroadWorks Anywhere also enables you to move calls between your desk phone and mobile phone as well as perform any additional functions, such as intercom calls, you would on your desk phone.

Contact your system administrator or your service provider for more information on using BroadWorks Anywhere.

### Enable BroadWorks Anywhere

You can enable BroadWorks Anywhere on your VVX business media phone, add locations that act as duplicates of your desk phone, and manage all your calls from those locations. VVX business media phones support up to 10 phone numbers added as BWA locations for each registered line.

You can save a location name, primary number, and alternate number for each location you add. When you add a location, you can also choose to enable the following settings:

- **Diversion Inhibitor**—Determines if diversion inhibitor must be enabled when extending a call to the remote BWA location.
- **Answer Confirmation Required** —Requires confirmation when a call is answered by a remote location.
- **Call Control**—Determines if call control is handled by the BWA location or by the BroadWorks server.

### Procedure

1. Select **UC-One** on the Home screen or navigate to **Settings > Features > UC-One Call Settings**.  
On VVX 1500 phones, navigate to **Menu > Features > UC-One Call Settings**.
2. Select a line.
3. Select **BroadWorks Anywhere** and press **Add**.
4. Enter information for the **Status**, **Name**, **Primary Number**, and **Alt. Number/SIP URI** fields, if applicable.
5. Choose the settings you want to enable.
6. Select **Save**.

## Edit BroadWorks Anywhere Locations

After you enable BroadWorks Anywhere and add locations on your VVX business media phone, you can edit the added locations.

### Procedure

1. Select **UC-One** on the Home screen or navigate to **Settings > Features > UC-One Call Settings**.  
On VVX 1500 phones, navigate to **Menu > Features > UC-One Call Settings**.
2. Select a line.
3. Select **BroadWorks Anywhere** and select a location.
4. Edit the selection.
5. Select **Save**.

## Disable BWA Locations

When you return to the office or want to stop remotely managing your calls, you can disable BWA locations.

### Procedure

1. Select **UC-One** on the Home screen or navigate to **Settings > Features > UC-One Call Settings**.  
On VVX 1500 phones, navigate to **Menu > Features > UC-One Call Settings**.
2. Select a line.
3. Select **BroadWorks Anywhere** and select a location.
4. Select **Status > Disabled**.
5. Select **Save**.

## Remove BWA Locations

You can choose to remove locations that you do not want to manage remote calls from anymore.

### Procedure

1. Select **UC-One** on the Home screen or navigate to **Settings > Features > UC-One Call Settings**.  
On VVX 1500 phones, navigate to **Menu > Features > UC-One Call Settings**.
2. Select a line.
3. Select **BroadWorks Anywhere** and select a location.
4. Press **Delete**.

## Managing Calls with BroadSoft UC-One Remote Office

With the Remote Office feature, you can forward all incoming calls to your VVX business media phone to a remote office number, such as your mobile or home office number, when you are away from the office.

You can answer all incoming calls to your desk phone on your mobile phone or home office phone, and any calls you place to contacts from your remote office number shows your desk phone number on the caller ID.

Contact your system administrator or your service provider for more information on using Remote Office.

### Add a Remote Office Number

You can add one number only as your remote office number.

#### Procedure

1. Select **UC-One** on the Home screen or navigate to **Settings > Features > UC-One Call Settings**.  
On VVX 1500 phones, navigate to **Menu > Features > UC-One Call Settings**.
2. Select a line.
3. Select **Remote Office**.
4. Enter your remote office number and press **Enabled**.
5. Select **Save**.

All calls made to your desk phone are forwarded to the remote office number.

### Disable Remote Office

When you return to the office or want to stop forwarding your calls, make sure you disable Remote Office.

#### Procedure

1. Select **UC-One** on the Home screen or navigate to **Settings > Features > UC-One Call Settings**.  
On VVX 1500 phones, navigate to **Menu > Features > UC-One Call Settings**.
2. Select a line.
3. Select **Remote Office > Disabled**.
4. Select **Save**.

### Edit Your Remote Office Number

You can edit your remote office number to add a different number for forwarding your calls.

#### Procedure

1. Select **UC-One** on the Home screen or navigate to **Settings > Features > UC-One Call Settings**.  
On VVX 1500 phones, navigate to **Menu > Features > UC-One Call Settings**.
2. Select a line.
3. Select **Remote Office**.
4. Enter the new number and select **Save**.

## Ignoring or Rejecting Incoming Calls

When you receive an incoming call, you can choose to ignore or reject the call instead of answering. You can reject or ignore incoming calls, reject incoming calls from a specific contact, or enable Do Not Disturb to reject all calls for a brief time period.

---

**Note:** You cannot reject calls on shared lines. You can only silence the ringer.

---

### Ignore or Silence an Incoming Call

You can ignore or silence a call to stop your phone from ringing. Even if you ignore the call and silence the ringer, an incoming call notification continues to display on your phone.

#### Procedure

1. From the **Incoming Call** screen, do one of the following:
  - Select **Ignore** for private lines.
  - Select **Silence** for shared lines.

The **Incoming Call** screen disappears, your phone stops ringing, and either the Home or Calls screen is displayed.

### Reject Incoming Calls

You can reject a call and send the call directly to voicemail. Rejected calls display in the Missed Calls list in your Recent Calls list. Rejecting calls is not available for shared lines.

#### Procedure

1. From the **Incoming Call** screen, select **Reject**.

The call goes directly to voicemail.

### Reject Calls from a Contact

You can send incoming calls from a particular contact directly to your voicemail.

#### Procedure



1. Navigate to **Directories > Contact Directory**.  
On VVX 1500 phones, press the **Directory** key and select **Contact Directory**.
2. From your **Contact Directory**, select a contact.
3. From the **Contact Information** screen, select **Edit** or tap .
4. From the **Edit Contact** screen, select **Auto Reject > Enabled** and select **Save**.  
Calls from the contact are sent directly to voicemail when the contact calls.



## Rejecting Calls with Do Not Disturb

Do Not Disturb (DND) enables you to set your phone to automatically reject calls when you do not want to be interrupted.

When you enable Do Not Disturb (DND), the following occurs:

- The DND icon  displays in the status bar.
- When the phone is idle, the DND icon is displayed next to your phone line on the Lines screen. If you have new messages or call forwarding is enabled, the messages or forwarding icon is displayed instead.
- The message “Do Not Disturb” is displayed in the status bar on all phones.
- The DND icon on the Home screen changes from  to .

For VVX 201 phones, the line icon changes to .

---

**Note:** When you set your presence status to Do Not Disturb, as well as enable DND for your phone, a message stating that your status is set to Do Not Disturb scrolls under the time display, and the DND icon does not display in the status bar.

---

## Enable Do Not Disturb

You can enable DND to prevent your phone from ringing and to send all incoming calls directly to voicemail. All calls you receive while DND is enabled are logged in your Recent Calls list.

Enabling DND on shared lines disables ringing only. A visual notification of the call still displays, and you have the option to answer or ignore the call.

---

**Note:** When you are signed into a host phone as a guest, you can only enable Do Not Disturb if the server-based Do Not Disturb feature is enabled on the phone. If server-based DND is disabled on the phone, you cannot use DND on the host phone. Contact your system administrator for help enabling this feature.

---

### Procedure

1. Select **DND**.  
On VVX 1500 phones, press the **DND** key.

## Reject Calls with Do Not Disturb on Multiple Lines

By default, the Do Not Disturb feature applies to all lines on your phone. Your system administrator can set up your phone so that you can enable the feature on a per-line basis.

### Procedure

1. Select **DND**.  
On VVX 1500 phones, press the **DND** key.
2. Select **Set All** to enable DND for all lines.

## Reject Calls with Do Not Disturb on One Line

If enabled, you can choose to enable DND for a particular line and not all lines.

**Procedure**

1. Select **DND**.  
On VVX 1500 phones, press the **DND** key.
2. From the **Line Select** screen, select a line.
3. From the **Do Not Disturb** screen, select **Enable**.

**Disable Do Not Disturb**

You can disable DND when you are ready to resume receiving calls again.

---

**Tip:** To quickly disable DND on VVX 600/601 phones, tap  in the status bar.

---

**Procedure**

1. Select **DND**.  
On VVX 1500 phones, press the **DND** key.

**Reject Anonymous Calls**

When your phone is registered with a BroadWorks server, and you are signed into the phone with your BroadSoft UC-One credentials, you can use the Anonymous Call Reject (ACR) feature to automatically reject anonymous calls to your line from callers who have restricted their caller identification.

Check with your system administrator to find out if this feature is available in your environment.

**Procedure**

1. Select **UC-One** on the Home screen or navigate to **Settings > Features > UC-One Call Settings**.  
On VVX 1500 phones, navigate to **Menu > Features > UC-One Call Settings**.
2. If your phone has multiple lines, select a phone line.
3. Select **Anonymous Call Reject**.
4. On the **Anonymous Call Reject** screen, select **Enabled**.

When an anonymous call is placed to your phone number, the call is automatically rejected, and the caller hears a message stating that you do not accept calls from unidentified numbers. Your phone does not ring, and you are not notified of an attempted call.

## Redirecting Incoming Calls

You can redirect incoming calls by forwarding an incoming call to a contact, forwarding all incoming calls to a contact, or diverting calls from a specific contact to another contact.

### Forwarding Incoming Calls to a Contact

You can choose to forward an incoming call to a contact or forward all incoming calls to one of your contacts.

---

**Note:** When you are signed into a host phone as a guest, you can only forward calls if the server-based Call Forwarding feature is enabled. If server-based Call Forwarding is disabled, you cannot forward calls to a contact from the host phone. Contact your system administrator for help enabling this feature.

---

#### Forward an Incoming Call to a Contact

You can forward an incoming call directly to a contact without answering the call.

You cannot forward calls in this way on shared lines.

##### Procedure

1. In the **Incoming Call** screen, select **Forward**.
2. From the **Call Forwarding** screen, enter the forwarding number, and select **Forward**.

#### Forward All Incoming Calls to a Contact

You can set up your phone to forward all incoming calls to a contact using one of the following forwarding types:

- **Always**—Forwards all incoming calls.
- **No Answer**—Forwards all unanswered incoming calls.
- **Busy**—Forwards incoming calls when you're in a call.

For shared lines, you can only choose **Always** as your forwarding type; the other forwarding options are not available for shared lines.

##### Procedure

1. Select **Forward** or navigate to **Settings > Features > Forward**.  
For VVX 1500 phones, navigate to **Menu > Features > Forward**.
2. If your phone has multiple lines, select a line.
3. On the **Forwarding Type Select** screen, select a forwarding type.
4. Enter a contact's number or IP address, if enabled, and select **Enable**.
5. If you selected the **No Answer** option, enter the number of rings before the call is forwarded.  
The forwarding number or name of the contact you chose scrolls in the status bar, and when you select **Always** as your forwarding option, the forwarding icon (→) is displayed on the line.

## Disable Call Forwarding

You can disable call forwarding when you no longer want to forward your calls.

### Procedure

1. Select **Forward**.
2. If your phone has multiple lines, select a line.
3. From the **Forwarding Type Select** screen, select your forwarding type, and select **Disable**.

## Divert Calls to a Contact

You can divert all incoming calls from a particular contact to another contact.

### Procedure

1. Select **Directories > Contact Directory**.  
On VVX 1500 phones, press the **Directory** key and select **Contact Directory**.
2. From the **Contact Directory**, select a contact.  
On VVX 1500 phones, select a contact, then tap **Edit**.
3. From the **Contact Information** screen, select **Edit** or tap .
4. From the **Edit Contact** screen, select **Divert Contact**, and enter a contact's number.
5. Select **Auto Divert > Enabled**.
6. Select **Save**.

# Conference Calls

---

## Topics:

- [Tips for Conference Calls](#)
- [Audio Conference Calls](#)
- [Alcatel-Lucent Advanced Conference Calls](#)

You can initiate audio conference calls with various contacts on your VVX business media phone. When you initiate a conference call, you can hear audio for two or more contacts, manage conference participants, and join calls into a conference or split a conference into individual calls.

## Tips for Conference Calls

When you are in a conference call, follow these tips:

- Use the handset or a headset if you're in an open environment.
- Mute your microphone when you are not speaking, especially in noisy environments.
- Avoid tapping or rustling papers near the microphone.
- Speak in your normal voice without shouting.

## Audio Conference Calls

You can initiate an audio conference call with two contacts and hold, resume, or split a conference call on your VVX business media phone.

VVX 101 and 201 phones can manage a maximum of four active or held conference calls at a time. All other VVX business media phones can manage a maximum of 12 active or held conference calls at a time. However, you can have only one active conference call in progress with numerous other conference calls on hold.

If your system administrator enables the Conference Management feature on your phone, you can manage each participant in the call. With the Conference Management feature, you can mute, hold, and remove individual participants in a conference call.

---

**Note:** If your phone is registered with Alcatel-Lucent CTS, you have different options for initiating and managing conference calls.

---

## Initiate a Conference Call

You can initiate a conference by calling two people and selecting the Conference soft key or hard key.

---

**Note:** When your phone is set up for single key press conferences, you do not need to tap the Conference soft key or press the Conference key a second time to join parties to a conference call.

---

### Procedure

1. Call a contact.
2. After the contact answers, select the **Conference** soft key, or on VVX 1500 phones, press the **Conference** key.  
The call is held.
3. Enter another contact's number or select a contact from the directory or the call lists.
4. When the contact answers, select the **Conference** soft key, or on VVX 1500 phones, press the **Conference** key.  
All call participants are added to a conference call.

## Join Calls to Create a Conference Call

You can join one active call and one held call into a conference call. If you have more than one call on hold, you can select a held call to join into a conference call with the active call.

### Procedure

1. Do one of the following:
  - When you have an active call and a held call, select the **Join** soft key.
  - When you have an active call and more than one held call, select a held call, and select the **Join** soft key.

The active call and the selected held call are joined into a conference. If you have multiple held calls, the other held calls on the line remain held.

## End a Conference Call

By default, when you end a conference call, your connection to the call ends, and the other participants in the conference remain in the call.

However, your system administrator can set up your phone so that all connections terminate when you end a conference call.

### Procedure

1. During a conference call, select **End Call**.

## Hold a Conference Call

When you place a conference call on hold, you place all conference participants on hold.

### Procedure

1. Select **Hold**.

## Resume a Conference Call

Resuming a held conference call enables all participants to hear the audio of everyone on the call.

### Procedure

1. Select **Resume**.

## Split a Conference Call

When you split a conference, you end the conference call and place the other two people on hold. You can split an active or held conference call. After you split a conference call, you can resume one of the held calls.

### Procedure

1. During a conference call, select the **Split** soft key.  
The conference call ends, and the two participants are held in two separate calls.

## Manage Conference Call Participants

If your system administrator enables the Conference Management feature on your phone, you can manage conference call participants in the following ways:

- Mute a participant.
- Hold a participant.
- Remove a participant from the conference.
- List information about a participant, such as the participant's name, number, and call details, including whether the call is muted, held, or is video-enabled.

This feature is not available for VVX 101 and 201 phones. Check with your system administrator to find out if this feature is available on your phone.

### Procedure

1. Initiate a conference call.
2. Select **Manage**.  
If you're in the Calls screen, highlight the conference first.
3. Select the participant you want to manage.
4. Do one of the following:
  - Select **Far Mute** to mute the participant. The muted participant can hear everyone, but no one can hear the muted participant.
  - Select **Hold** to hold the participant. The held participant cannot hear anyone, and no one can hear the held participant.
  - Select **Remove** to remove the participant from the conference, end the conference call, and create an active call between you and the participant still in the call.
  - Select **Information** to view information about the participant's call status. When you select **Information**, a screen is displayed listing the person's information, as shown next.

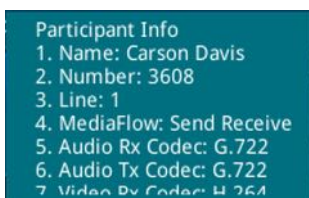

5. Select **Back** to exit the conference management function.

## Alcatel-Lucent Advanced Conference Calls

When you are registered with the Alcatel-Lucent CTS on your VVX phone, you can initiate impromptu audio conference calls with two or more contacts from your phone. You can also create a participant list and manage conference participants. You can manage a maximum of 24 advanced conference calls at a time on your phone, if enabled on the server. However, you can have only one active conference call in progress on your phone.

This feature is not supported on VVX 101, 201, and 1500 phones. Check with your system administrator to find out if this feature is available on your phone.

### Initiate an Advanced Conference Call

You can initiate an advanced audio conference call, add and invite contacts to the audio conference call, and have up to 24 audio conference calls on your phone. You can also initiate an audio conference call from an active call.

#### Procedure

1. Press **Meet Now**.
2. Press **Invite** and choose the contacts you want to add to the conference from a directory, Recent Calls, or Favorites.
3. Press **Invite**.

The Roster screen displays with a list of participants in the conference.

### Initiate an Advanced Conference Call During a Call

During an active call on your phone, you can add contacts to the call to initiate a conference call.

#### Procedure

1. During an active call, select the **Conference** soft key.  
The call is held.
2. Enter another contact's number or select a contact from the directory or the call lists.
3. When the contact answers, select the **Conference** soft key.  
All call participants are added to a conference call.



## Add Contacts to an Advanced Conference Call

During a conference call, the chairperson—the person who initiated the conference call—can invite additional contacts to the call.

### Procedure

1. During a conference call, press **Invite**.
2. Select a contact to join the meeting.

## Join Calls to an Advanced Conference Call

The conference host can join incoming calls to a conference. Conference participants cannot add incoming calls to a conference.

### Procedure

1. During a conference call, answer the incoming call.
2. Press the **Join** soft key.  
The call is joined to the conference call.

## Join Two Calls into an Advanced Conference Call

You can join an active call and a held call into an advanced conference call.

### Procedure

1. Do one of the following:
  - When you have an active call and a held call, select the **Join** soft key.
  - When you have an active call and more than one held call, select a held call, and select the **Join** soft key.

The active call and the selected held call are joined into a conference. If you have multiple held calls, the other held calls on the line remain held.

## Viewing a Roster of Conference Participants

When you initiate or join a conference call, all conference participants automatically display in a Roster. The roster only displays participants in the conference call; it does not display any calls on hold.

### Exit Participant Roster

When you exit the Roster, you cannot view the list of conference participants.

### Procedure

1. Press **Exit**.

### Return to Participant Roster

You can return to the Roster at anytime during an active conference.

**Procedure**

1. Press **Roster**.

**Managing Advanced Conference Participants**

When you initiate or join a conference call, the conference participants are automatically displayed in a Roster. From the Roster, the chairperson (the person who initiated the conference call) can mute and remove individual participants from the conference.

**Muting Advance Conference Participants**

Chairpersons can mute all conference participants at one time or mute an individual participant. Only chairpersons can mute and unmute conference participants.

If a chairperson mutes a participant's audio, a mute icon is displayed in the Roster next to each person who is muted.

**Mute and Unmute All Advanced Conference Participants**

Chairpersons can mute and unmute all conference participants at one time.

**Procedure**

1. Press **Mute All**.
2. Press **Unmute** to enable participants to speak in the conference.

**Mute and Unmute Individual Advance Conference Participants**

Chairpersons can choose to mute and unmute individual participants during conferences.

**Procedure**

1. Select a participant and press **Far Mute**.
2. Select the muted participant and press **Unmute**.

**Remove Advanced Conference Participants**

A chairperson can remove any participant from the conference call.

**Procedure**

1. In the Roster, select a participant and select **Remove**.

# Shared Lines

---

## Topics:

- [Shared Line Limitations](#)
- [Answering Calls on Shared Lines](#)
- [Missed and Received Calls on Shared Lines](#)
- [Hold a Call Privately on a Shared Line](#)
- [Barge In on Calls for Busy Lamp Field Lines](#)
- [GENBAND's Multiple Appearance Directory Number - Single Call Appearance](#)
- [Alcatel-Lucent Shared Call Appearance](#)
- [BroadSoft UC-One Simultaneous Ring](#)
- [BroadSoft Executive-Assistant](#)

All VVX business media phones, except VVX 101, support multiple and shared lines. Your administrator can customize your phone so that you have multiple shared lines enabled.

## Shared Line Limitations

The following features are not available or have limitations on phones with shared lines:

- Forwarding an incoming call is not available.
- Enabling Do Not Disturb on shared lines disables ringing only, and a visual notification of the call is displayed with the option to answer the call.
- Registering lines as shared lines is not available for lines that use the H.323 protocol.

## Answering Calls on Shared Lines

Incoming calls to a shared line causes all registered phones to ring, and the call can be answered on any of the phones. When you or another person answers the incoming call, a green indicator light is displayed on the line key on all phones for the shared line.

## Missed and Received Calls on Shared Lines

When you have an incoming call on a shared line, which none of the phones answer, the call is displayed in the Missed Calls list on all the phones. If you have an incoming call on a shared line and you or any of the other phones answer the call, the call is not logged as missed on any phone.

Your administrator can configure the phones so that if you have an incoming call on a shared line and one phone answers, the other phones log the call as a received call. That way, if another phone on a shared line answers an incoming call, you can still view the call information from your phone's call lists even if you did not answer the call.

## Hold a Call Privately on a Shared Line

When you place a call on hold on a shared line, all of the phones registered with that line are notified of the call's held status. You can hold a call privately on a shared line using the Private Hold feature, which places the call on hold and displays the line as busy on the other phones on the shared line.

When the Private Hold feature is enabled, the Pvt Hold soft key is displayed, and you can hold a call privately, transfer a call, or initiate a conference call without notifying others on the shared line of the call's held state.

Check with your system administrator to find out if this feature is available in your environment.

### Procedure

1. During a call, press **More > Pvt Hold**.

The call is held on your phone, and the line shows as busy on the other shared line users' phones.

When you hold a call privately, other users on the shared line cannot resume or pick up the call. However, users on the shared line can barge in on privately held calls. In order to allow other users to resume the call, you have to publicly hold the call by pressing the Hold key or soft key.

When Private Hold is enabled, you can also transfer a call or initiate a conference call without the other shared line users being notified of the call's status. When you press the Transfer or Conference soft key on the shared line, the call is held privately. If you press Hold before you transfer a call or initiate a conference, the other users on the shared line are notified of the call's held status.

## Barge In on Calls for Busy Lamp Field Lines

When your phone is registered with the Alcatel-Lucent CTS, you and other contacts can barge in on active calls for Busy Lamp Field (BLF) lines you all are monitoring.

Only one contact can barge in on a call at a time, and contacts cannot barge in on parked calls. Contacts can also barge in on remote held calls using the Normal barge in mode.

This feature is not supported on VVX 101, 201, and 1500 phones. Check with your system administrator to find out if this feature is available on your phone.

You can barge in on a call using one of the following modes:

- **Normal (audio and video calls)**—Initiates a conference call with you and the contacts currently in the call.
- **Whisper (audio-only)**—Enables you to barge in on audio calls only to talk to a contact in the call without the far-end hearing your audio. This mode is not available for video calls.
- **Listen (audio-only)**—Enables you to barge into audio calls only and listen to the other parties' conversation without anyone hearing your audio. This mode is not available for video calls.

### Procedure

1. During an active call, select **Barge In**.
2. On the **Barge In** screen, select a mode.

If enabled, a tone plays when you barge into a call using any of the modes.

## GENBAND's Multiple Appearance Directory Number - Single Call Appearance

When your phone is registered with the GENBAND server, you can use the Multiple Appearance Directory Number - Single Call Appearance (MADN-SCA) feature to share a single line with other contacts as a member of a Multiple Appearance Directory Number (MADN) group. System administrators assign members to MADN groups, which can have a maximum of 32 members. Check with your system administrator to find out if this feature is available on your phone.

Any MADN group member can place, answer, hold, resume, or barge in on a call on a shared line. Additionally, all group members can view the status of a call on the shared line on their phones.

### Placing a MADN Call

Any MADN member can place a call on the shared line. When a member places a call on the shared line, the other members are notified with a steady red LED light on the line key of the members' phones.

Only one call at a time can be active on the shared line. If a call is placed to the shared line with an active call in place, the incoming call is sent to voicemail.

### Answering a MADN Call

Any incoming call to the shared line rings on all group members' phones simultaneously, the call is displayed on all members' screens, and a green LED light flashes on the line's line key.

Any MADN member can respond to an incoming call to the shared line. When a MADN member answers an incoming call, the LED indicator on the line key for all phones changes to a steady red light to indicate the call was answered. Members can also view the status of a call on the shared line by pressing and holding the corresponding line key for one second. The call's status and the Barge In soft key display for five seconds.

If bridging is disabled and privacy is enabled for the shared line, you cannot barge in on active calls answered by other MADN members.

### Barge In on an Active Call

After a call is answered, any group member can barge in on the active call on a public shared line, which becomes a bridge call—a call between two or more MADN members and another party. Ask your system administrator about the maximum number of participants allowed on a bridge call.

#### Procedure

1. Press and hold the corresponding line key for the shared line for one second.
2. Select the **Barge In** soft key and lift the handset.

A bridge tone plays notifying the other call participants that you are barging in on the call.

### Leave a Bridge Call

Any member in a bridge call can leave the call, and the call remains active.

After you leave a bridge call, you can rejoin by pressing the Barge In soft key again.

### Procedure

1. Select the **End Call** soft key, or place the handset in the cradle.  
Your connection to the bridge call is ended, and the other call participants remain on the call.

## Resume a Held MADN Call

Any MADN member can resume a held call on the shared line. When an active call is placed on hold on the shared line, all group members are notified of the call's new status by a flashing red LED light on the line key on all members' phones, if enabled by your system administrator.

When a held call is resumed by another MADN member, the other group members are notified of the call's new status with a steady red LED light on the line key on the members' phone.

### Procedure

1. Do one of the following:
  - Select the corresponding line key and lift the handset.
  - Press and hold the corresponding line key and select **Resume**.

## Enabling Privacy

Any MADN member can temporarily enable privacy for an active or bridge call on a public shared line using privacy codes or privacy soft keys configured by your system administrator.

Additionally, MADN members can use privacy codes and soft keys to temporarily disable privacy on an active call on a private shared line.

The following are three types of privacy codes that you can use to enable and disable privacy on a shared line:

- Privacy Access (PRV) code—Enables privacy for an active call on a public line.
- Privacy Release Activation (PRLA) code—Disables privacy for an active call on a private shared line.
- Privacy Release Cancel (PRLC) code—Re-enables privacy for an active call on a private shared line.

When a shared line is configured as private or when privacy is enabled on an active call, bridging is disabled and other MADN members cannot barge in on an active call on the shared line.

## Enable Privacy

After you enable privacy for an active call on a public shared line, you cannot disable privacy for the call. You can allow other MADN members to join the active call by transferring the call or initiating a conference call.

### Procedure

1. During an active call, do one of the following:
  - Select **Transfer** and dial the PRV code given to you by your administrator  
For example, dial \*91.
  - Select the **Priv** soft key, if enabled.

A confirmation tone plays, and the call is resumed automatically.

## Disable Privacy Temporarily

You can temporarily disable privacy for an active call on a private shared line to allow other MADN members to join the call.

### Procedure

1. During an active call, press the **PRLA** soft key or select **Hold** and dial the PRLA code given to you by your administrator.

For example, dial \*921.

A confirmation tone plays, and the call is resumed automatically. Privacy is disabled for the call and any member can barge in on the call.

2. After other MADN members have joined the call, press the **PRLA** soft key or select **Hold** and dial the PRLC code given to you by your administrator.

For example, dial \*922.

A confirmation tone plays, and the call is resumed automatically.

## Enable Privacy on a Bridge Call

You can enable privacy on a bridge call to prevent additional MADN members from barging into the call.

### Procedure

1. During a bridge call, select **Transfer** and dial the PRV code or select the **Privacy** soft key, if enabled.

A confirmation tone plays when privacy is enabled, and the call is resumed automatically. The bridge call is now private and additional MADN members are not allowed to join the call.

## Alcatel-Lucent Shared Call Appearance

When your phone is registered with the Alcatel-Lucent CTS, you can use the Shared Call Appearance (SCAP) feature to share a single line with other contacts as a member of a group. System administrators assign members to SCAP groups.

This feature is not supported on VVX 101 and 1500 phones. Check with your system administrator to find out if this feature is available on your phone.

Any SCAP group member can place, answer, hold, or resume calls on the line. SCAP group members can also bridge in on a call on the shared line. Additionally, all group members can view the status of a call on the shared line on their phones. Each line supports up to 21 call appearances.

### Placing a SCAP Call

Any group member can place a call on the shared line. When a member places a call on the shared line, the other members are notified with a steady red LED light on the line key on members' phones. Multiple group members can place outgoing calls while a call is in progress on the shared line.

### Answering a SCAP Call

Any incoming call to the shared line rings on all group members' phones simultaneously, the call is displayed on all members' screens, and a green LED light flashes on the line key.

Any group member can respond to an incoming call to the shared line. When a group member answers an incoming call, the line key's LED indicator on all phones changes to a steady red light to indicate the call was answered. Members can also view the status of a call on the shared line by pressing and holding the corresponding line key for one second. The call's status and the Bridge In soft key display for five seconds.

## Bridge In to an Active Call

Multiple group members can bridge into one call if the call is public. After a group member bridges into a call, the call becomes a bridge call—a call between two or more SCAP members and another party.

Ask your system administrator about the maximum number of participants allowed on a bridge call.

If the call is private or if bridging is disabled, the Bridge In soft key does not display or you cannot bridge into active calls answered by other group members.

### Procedure

1. Press and hold the line key with the active call for one second.
2. Select **Bridge In**.

If enabled, a bridge tone plays notifying the other call participants that you are bridging in on the call.

## Leave a Bridge SCAP Call

Any member in a bridge call can leave the call, and the call remains active.

### Procedure

1. Select the **End Call** soft key, or place the handset in the cradle.  
Your connection to the bridge call is ended, and the other call participants remain on the call.  
You can rejoin a bridge call after leaving by pressing the **Bridge In** soft key again.

## Make an Active Call Public

By default, all active calls on the shared line are private. After a call is answered, you can make the call public and enable other SCAP members to bridge into the active call.

### Procedure

1. During an active call, select **Share**.  
The call is now public, the Private soft key is displayed, and other group members can bridge into the call.

## Make an Active Call Private

After you make a call public and allow group members to bridge into the call, you can make the call private to prevent more group members from bridging into the call.

### Procedure

1. During an active bridge call, select **Private**.



The call is now private and other group members cannot bridge into the call.

## Holding or Passing Calls

You can choose to hold or pass a call on the shared SCAP line. When you place a call on hold, the call is held on your phone, only you can view the held status of the call, and only you can resume the call.

Passing a call enables other group members to resume the call on the shared line.

### Pass an SCAP Call

When you pass a call, you enable SCAP group members to view the held status of the call and resume the call.

You cannot pass active bridge calls on the shared line.

#### Procedure

1. During an active call, select **Pass**.

The call is placed on hold, and all members on the shared line can view and resume the passed call.

### Resume a Passed SCAP Call

Any group member can resume a passed call on the shared line.

When an active call is passed on the shared line, all group members are notified of the call's new status by a flashing red LED light on the line key on all members' phones, if enabled by your system administrator.

When a passed call is resumed by another group member, the other group members are notified of the call's new status with a steady red LED light on the line key on the members' phone.

#### Procedure

1. Do one of the following:
  - Select the corresponding line key and lift the handset.
  - Press and hold the corresponding line key and select **Resume**.

## BroadSoft UC-One Simultaneous Ring

When your phone is registered with a BroadWorks server and you are signed into the phone with your BroadSoft UC-One credentials, you can use the Simultaneous Ring feature to add a list of up to 10 extensions and phone numbers that will ring simultaneously when you receive an incoming call on your line.

When the incoming call is answered on one of the phones added to your Simultaneous Ring list, the call is logged in the Missed Calls list on the other phones. Unanswered incoming calls are logged in the Missed Calls lists on all connected phones.

Check with your system administrator to find out if this feature is available on your phone.

## Create a Personal Ring Group

Before you can add numbers to your personal ring group, you need to enable the Simultaneous Ring feature on your phone.

### Procedure

1. Select **UC-One** on the Home screen or navigate to **Settings > Features > UC-One Call Settings**.  
On VVX 1500 phones, navigate to **Menu > Features > UC-One Call Settings**.
2. Select a line.
3. Select **Simultaneous Ring Personal**.
4. Select **Status > Enabled**.

## Add Numbers to Your Simultaneous Ring List

You can add up to 10 extensions and phone numbers to the Simultaneous Ring list.

When you add an extension or a phone number, you can choose to enable Answer Confirmation Required, which notifies you when a call is answered on one of the added numbers.

### Procedure

1. Select **UC-One** on the Home screen or navigate to **Settings > Features > UC-One Call Settings**.  
On VVX 1500 phones, navigate to **Menu > Features > UC-One Call Settings**.
2. Select a line.
3. Select **Simultaneous Ring Personal > Add**.
4. Enter an extension or phone number.
5. Select **Answer Confirmation Required** to receive confirmation that the call was answered.
6. Select **Save**.

You cannot pick up or barge in on calls answered on another phone. The contact who answers the call must transfer the call to your phone or park the call on your line for you to speak with the caller.

## Delete Numbers from the Simultaneous Ring List



You can delete a number added to your Simultaneous Ring list at any time.

### Procedure

1. Select **UC-One** on the Home screen or navigate to **Settings > Features > UC-One Call Settings**.  
On VVX 1500 phones, navigate to **Menu > Features > UC-One Call Settings**.
2. Select a line.
3. Select **Simultaneous Ring Personal**.
4. Select the numbers you want to remove and press **Delete**.

## BroadSoft Executive-Assistant

The BroadSoft Executive-Assistant feature enables assistants to monitor an executive's calls, place calls on behalf of an executive, filter and divert executive calls, and opt-in or out of monitoring calls for an executive. Executives can resume held calls on the assistant's phone, screen calls on the executive's line, and barge in on executive calls on the assistant's phone.

When your system administrator assigns you as an executive or assistant, the Executive  or Assistant  menu icons and soft keys display on your phone.

Executives and assistants can both have a private and shared line on their phone. Executives can have private and shared lines that are not managed by an assistant.

The following conditions apply to private or shared lines set as an Executive or Assistant:

- For shared lines, the status of any executive calls display on the shared line on the executive and assistant's phone.
- Assistants can use their private line to place a call or answer calls on behalf of an executive, but an assistant or executive cannot view the status of calls on a private line.
- For private lines, executives and assistants can pick up held calls on the assistant's or executive's phone, but cannot choose which held call is picked up.

### Filter Executive Calls

Executives can enable Call Filtering on their phones to send all executive calls directly to an assistant to answer, and the executives is not alerted of the incoming call. You can set additional call filtering settings in the BroadSoft BroadCloud portal.

#### Procedure

1. On the executive's phone, navigate to **Settings > Basic > Executive Settings**.
2. Select **Call Filtering**, then select **On**.

Incoming calls to the executive's line are sent directly to the assistant, and the executive is not notified of the call.

### Filter Calls for an Executive

As an assistant, you can enable Call Filtering for an executive from your phone.

#### Procedure

1. On the assistant's phone, navigate to **Settings > Basic > Executive Management**.
2. Select **Executives**, then choose an executive.
3. Select **Call Filtering**, then select **On**.

Incoming calls to the executive's line are sent directly to the assistant, and the executive is not notified of the call.

## Screen Executive Calls

Executives can enable Call Screening, which displays the incoming call notification for all filtered executive calls on the executive's phone. Call Screening is only available when Call Filtering is enabled.

### Procedure

1. On the executive's phone, navigate to **Settings > Basic > Executive Settings**.
2. Select **Call Screen**, then select **On**.

## Enable Call Screening for an Executive

As an assistant, you can enable Call Screening for an executive from your phone. Call Screening is only available when Call Filtering is enabled.

### Procedure

1. On the assistant's phone, navigate to **Settings > Basic > Executive Management**.
2. Select **Executives**, then choose an executive.
3. Select **Call Screening**, then select **On**.

The executive receives the incoming call notification for all filtered executive calls.

## Answering Executive Calls

When a call is placed to an executive's line, and Call Filtering is enabled, the call is displayed on the assistant's phone only. Incoming call notifications for an executive call displays with the executive's name in the notification on the assistant's phone. Assistant's can answer, reject, or ignore any executive calls.

When Call Screening is enabled, incoming call notifications also display on the executive's phone, and the executive can choose to answer the call.

## Place a Call on Behalf of an Executive

As an assistant, you can make calls on behalf of any of your assigned executives. When a call is made on behalf of an executive, a solid red bar is displayed on the executive's line key, if the executive's line is a shared line.

### Procedure

1. Press the **Executive** soft key, and choose an executive.
2. Select **On behalf**, and enter the contact's number or choose a contact from Recent Calls or the directory.
3. Select **Dial** or tap .

The executive's caller information displays on the third-party's phone.

## Pick Up a Held Executive Call on a Shared Line

Executives and assistants can both pick up held calls on shared or private executive lines. On shared lines, the executive and assistant can both view the status of calls on the other's phone and choose which call to pick up.

**Procedure**

1. Press and hold the line key with the held call.
2. Select the held call, and select the **Pick Call** soft key.

**Pick Up a Held Executive Call on a Shared Line**

Executives and assistants can both pick up held calls on shared or private executive lines. On shared lines, the executive and assistant can both view the status of calls on the other's phone and choose which call to pick up.

**Procedure**

1. Press and hold the line key with the held call.
2. Select the held call, and select the **Pick Call** soft key.

**Pick Up a Held Executive Call on a Private Line**

On private lines, the executives and assistants can pick up held calls on the other's phone, but they cannot view the status of a call or choose which held call to pick up.

**Procedure**

1. On the Home screen, select the **Executive** menu.
2. Select an executive, then select **Pick Call**.

**Barge In on an Executive Call**

When there is a call on the executive's line, the executive or the assistant can barge in on the call. When you barge in on the call, all parties are notified that you have barged in on the call, and you can talk with the other parties on the call.

**Procedure**

1. During an active call on the executive's line, press and hold the executive line key.
2. Select the **Barge In** soft key.

**Silently Barge In on an Executive Call**

In addition to barging in on a call, executives can silently barge in on the call and listen to the call without anyone knowing the executive is on the call. When you silently barge in on a call, the other parties are not notified that you barged in, no one can hear your audio, and you cannot talk to the other parties on the call.

Assistants cannot silently barge in on executive calls.

**Procedure**

1. During an active call on the executive's line, press and hold the executive line key.
2. Select the **S-Barge In** soft key.

## Opt In or Opt Out of being an Assistant for an Executive

As an assistant, you can choose to opt in or opt out of being an assistant and monitoring calls for an executive.

When you opt-in to being an assistant for an executive, you can monitor and manage all filter calls to the executive. When you opt out, you no longer receive filtered executive calls, and you cannot manage or monitor executive calls.

### Procedure

1. Navigate to **Settings >Basic > Executive Management**.
2. Select **Executives**, then choose an executive.
3. Select **Opted-In**, then do one of the following:
  - Select **Yes** to opt in to being an assistant for an executive.
  - Select **No** to opt out of being an assistant for an executive.

## Divert Filtered Executive Calls

As an assistant, you can choose to divert filtered calls for all assigned executives to another assistant, contact, or phone.

### Procedure

1. Navigate to **Settings >Basic > Executive Management**.
2. Select **Call Diversion**, then select **Yes**.
3. Enter the number where you want to divert executive calls.

# Recording Audio Calls

---

## Topics:

- [Guidelines when Recording Calls](#)
- [Record a Call](#)
- [Manage a Call while Recording](#)
- [Pause a Recording](#)
- [Resume a Recording](#)
- [Stop Recording](#)
- [Record a Conference Call](#)
- [Browse Recorded Calls](#)
- [Play a Recorded Call](#)
- [Pause and Resume Played Recordings](#)
- [Stop Playing a Recording](#)
- [Rename a Recording](#)
- [Delete a Recording](#)

On VVX 401/411, 500/501, 600/601, and 1500 phones, you can record audio calls onto a USB flash drive connected to your phone. Recordings are stored as .wav files on the USB flash drive, and you can record up to four hours in one file. For a list of supported USB flash drives to record phone audio, see *Technical Bulletin 38084: Supported USB Devices* on [Polycom Support](#).

---

**Note:** To attach a USB flash drive, see the Quick Start Guide for your VVX phone on your phone's support page on [Polycom Voice Support](#).

---

**Note:** If your phone does not detect the USB flash drive when you attach it to the phone, the USB port may be disabled. Contact your system administrator for assistance.

---

## Guidelines when Recording Calls

The following are a list of guidelines to follow when recording audio calls:

- Inform contacts when you are recording a call.
- Make sure you mute your audio when you are placed on hold while recording the call. When you place a call on hold while recording, the recording pauses. However, when another person places you on hold, the recording continues.
- During an active call, pause your recording before answering incoming calls. All incoming calls you answer after you start recording are also recorded in the same file. For example, on June 22, 2012, at 11:22 a.m., you answer a call from person A. During your call with person A, you answer calls from person B and person C. All three calls are recorded in the same file.

## Record a Call

You can record all active audio calls on the phone. You cannot record calls when there are no connected calls, when you place a new call to transfer a call or initiate a conference, or when you have an incoming call.

Make sure to inform your contacts on the call before you begin recording.

Note that some tones made on your contact's phone are recorded. When you mute the microphone while recording, your audio is muted and only other participants' audio in the call are recorded.

### Procedure

1. During an active call, select **Record > Start**.  
The message "Recording in progress" is displayed in the status bar.

## Manage a Call while Recording

You can hold, end, transfer, or set up a conference call while you record, or while a recording is paused.

### Procedure

1. During a recording, select **Back** and choose a task to perform.
2. Select **Record** to view the Recording soft keys again.

## Pause a Recording

You can pause a recording during a call at any time while the call is active.

### Procedure

1. Select **Pause**.  
The message "Recording Paused" is displayed in the status bar.

## Resume a Recording

When you resume a recording after pausing, the recording continues within the same file.

### Procedure

1. Select **Resume**.

## Stop Recording

You can choose to stop recording a call before the call ends. The recording also stops when the active call ends, no matter who ended the call.



---

**Caution:** Do not remove the USB flash drive while recording. The file being recorded will be incomplete and cannot be played back later. When you remove the USB flash drive while recording, you can also damage the flash drive.

---

### Procedure

1. Do one of the following:
  - Select **Stop**.
  - Select **Back > End Call**.

When you stop recording, the USB icon is displayed in the status bar.

## Record a Conference Call

You can record a conference call in the same way as an active call with the following exceptions:

- All conference call participants are recorded. When a conference participant mutes his or her audio, that participant is not recorded.
- When you place a conference call on hold, the recording pauses. You can place or answer other calls, which are recorded in the same file. When you resume the conference call, the recording resumes.

### Procedure

1. During an active conference call, select **Record > Start**.  
The message “Recording in progress” is displayed in the status bar.

## Browse Recorded Calls

On a VVX Business Media Phone, you can browse recorded files stored on the USB drive.

### Procedure

1. Navigate to **Settings > Features > Removable Storage Media > Browse Recordings**.  
For VVX 1500 phones, navigate to **Menu > Settings > Features > Removable Storage Media > Browse Recordings**.

A list of recordings display.

## Play a Recorded Call

You can play back calls that you recorded on a USB drive on a VVX Business Media Phone.

If the handset is off-hook when you play a recording, the audio plays through the handset. If the handset is on-hook when you play a recording, the audio plays through the speaker.

---

**Note:** You cannot open and play recordings when you are in an active call or if you're recording a call. If you try to, a message indicating that the action was canceled is displayed. Place the call on hold before playing the recordings. The recording stops playing when you resume the call.

---

### Procedure

1. Navigate to **Settings > Features > Removable Storage Media > Browse Recordings**.  
For VVX 1500 phones, navigate to **Menu > Settings > Features > Removable Storage Media > Browse Recordings**.  
A list of recordings display.
2. Select a recording.
3. Select **Open > Play**.  
The length of the recording and a progress bar is displayed as the recording plays.

## Pause and Resume Played Recordings

While playing a recording, you can pause the recording, perform another task on the phone, and resume the recording at any time.

When you receive an incoming call while playing a recording, the recording is paused automatically. If you do not answer or reject the incoming call, the recording remains paused until you select Resume.

### Procedure

1. While the recording plays, select **Pause**.
2. Select **Resume** to continue playing the recording.

## Stop Playing a Recording

When you are finished listening to a recording, you can stop playing it by exiting the recording.

### Procedure

1. Select **Exit**.

## Rename a Recording

By default, recordings are labeled with the date of the recording. You can rename recordings to provide them with more meaningful names.

### Procedure

1. Navigate to **Settings > Features > Removable Storage Media > Browse Recordings**.  
For VVX 1500 phones, navigate to **Menu > Settings > Features > Removable Storage Media > Browse Recordings**.  
A list of recordings display.

2. Select a recording.
3. Select **Rename**, update the file name, and select **OK**.

## Delete a Recording

When you have played a recording or need additional space on your USB drive, you can delete recordings from the phone.

### Procedure

1. Navigate to **Settings > Features > Removable Storage Media > Browse Recordings**.  
For VVX 1500 phones, navigate to **Menu > Settings > Features > Removable Storage Media > Browse Recordings**.  
A list of recordings display.
2. Select a recording.
3. Select **Delete**.

# Video Calls on VVX Business Media Phone

---

## Topics:

- [Tips for Video Calls](#)
- [Using a VVX Camera](#)
- [Video Call Settings](#)
- [Place a Video Call](#)
- [Swap Video](#)
- [Display Video Calls in Full Screen](#)
- [Exit Full Screen View](#)
- [Stop Sending Video](#)
- [No Video from the Far Side](#)
- [Handling Video and Audio Calls](#)
- [Managing Video Calls without a VVX Camera](#)
- [Place Audio-Only Calls](#)

Your administrator can enable your VVX 1500, 500/501 and 600/601 phone to receive and transmit video during calls. The VVX 1500 phones have a built-in camera, but the VVX 500/501 and 600/601 phones need a Polycom® VVX® Camera to transmit video. The VVX Camera is an optional accessory that attaches to the USB port on the VVX 500/501 and 600/601 phones. See the [VVX Camera Support](#) page for information on how to attach the camera to your phone.

If you do not have a VVX Camera attached to your VVX 500/501 or 600/601 phone when you receive video during calls, you can see your contact's video, but your contact cannot see video from you.

---

**Note:** Some of the features described in this section require access to the Basic settings menu. If your phone requires a password to access the Basic settings menu, contact your system administrator for assistance.

---

## Tips for Video Calls

Use these tips when you're in a video call:

- Check your video image to make sure it's clear, bright, and sharp.
- Avoid bright lights or windows behind you. If the camera faces a window or bright lights, adjust the camera settings.
- Avoid wearing bright colors, all-light or all-dark clothing, or busy patterns, such as small checks or narrow stripes. Pastels and muted colors look best on the screen.
- Use natural gestures and speak in a natural tone without shouting.
- Pause between sentences to allow for possible audio delay.

- During a conference call, mute your microphone when not speaking.
- Avoid tapping or rustling papers near the microphone.

## Using a VVX Camera

With the Polycom VVX Camera attached to your VVX 500/501 or 600/601 phone, you can transmit video to contacts during calls.

For information on attaching the VVX Camera to your phone, see the *VVX Camera Quick Start Guide* on the [VVX Camera Support](#) page. Check with your system administrator to make sure your phone has the correct software and is enabled to handle video calls.

The following figure shows the VVX 500/501 phone with a VVX Camera attached.

**VVX 500/501 phone and VVX Camera**



After the camera is attached to your phone, a message indicating that your camera firmware is updating and syncing with your phone displays. Do not remove the camera during this process. After your phone and camera sync, the message “Camera ready” is displayed, and your camera is ready to use.

---

**Note:** If your phone does not detect the VVX Camera when you attach it to your phone, the USB port on your phone may be disabled. Contact your system administrator for more information.

---

## Control the Lens Angle

On your VVX Camera, you can control the lens angle for video calls.

### Procedure

1. On the top of the camera, slide the Lens Adjuster backward or forward slowly until the camera is at the desired angle.

## Stop Sending Video with the Privacy Shutter

You can use the privacy shutter on the VVX Camera to stop transmitting video during a call.

### Procedure

1. On the side of the camera lens, rotate the Privacy Shutter Adjuster from the left to the right.

## Status Indicators and Messages for the VVX Camera

This section includes the status indicators and messages that display on your phone for the VVX Camera connected to your VVX phone.

### VVX Camera LED Indicators

LED State	Phone State
No LED	One of the following: <ul style="list-style-type: none"> <li>• Phone has no power</li> <li>• Camera shutter is closed</li> </ul>
Flashes red and green	Camera is booting up
Flashes amber and green	Camera firmware is updating
Flashes green	Incoming video call
Green	Video call is connected
Amber	One of the following: <ul style="list-style-type: none"> <li>• Incoming call (no video or audio-only)</li> <li>• Outgoing call</li> <li>• Audio call is connected</li> <li>• Video is muted</li> <li>• Held call</li> <li>• Camera shutter is open, but video is not enabled and camera is not selected</li> </ul>

### VVX Camera Messages

Message	Action
VVX Camera attached. Firmware sync in progress, do not remove camera.	Your camera is upgrading. Do not remove your camera during this process. The upgrade is complete when you receive a message stating that either "firmware sync complete" or "upgrade failed".
VVX Camera firmware sync complete. Camera ready.	Indicates that your camera is ready to use.
VVX Camera firmware sync complete. Contact administrator to enable video.	Indicates that your camera is ready to use. However, your phone is not enabled to send and receive video. Contact your system administrator to enable video calls.
VVX Camera firmware sync complete. Camera rebooting.	Indicates that the camera firmware sync is finished, and your camera is in the process of rebooting.

VVX Camera firmware sync complete. Video available when next idle.	Indicates that your camera is ready to use for your next video call.
VVX Camera attached, camera ready.	Indicates that your camera is ready to use.
VVX Camera attached. Contact administrator to enable video.	Indicates that your camera is ready to use. However, your phone isn't enabled to send and receive video. Contact your system administrator to enable video calls.
VVX Camera attached. Video available when next idle.	Indicates that your camera is ready to use for your next video call.
VVX Camera removed.	Indicates that you have detached your camera from your phone.
VVX Camera is not connected	Indicates that a VVX Camera is not attached to your phone, but you are accessing a feature or function that requires that the camera be attached.

## Video Call Settings

You can update video settings to change the way video calls display on your VVX 1500, 500/501 and 600/601 phone. Note that if you update settings during a call, the new settings apply to the next call and not the current call.

### Set the Call Rate for Video Calls

You can set the maximum call rate to use for a video call, and the selected call rate applies to your next video call. Your system administrator can set a maximum call rate for video calls, and you cannot select a call rate above this limit.

#### Procedure

1. Navigate to **Settings > Basic > Call Rate**.  
For VVX 1500 phones, navigate to **Menu > Settings > Basic > Call Rate**.
2. From the **Call Rate** screen, select the maximum call rate you want to use for video calls.  
You can choose a call rate between 128 kbps and 768 kbps. The default setting is 512 kbps.

### Stop Video for All Calls

You can stop your phone from automatically transmitting your video at the start of all calls by disabling the Auto Start Video Tx setting. The default setting is enabled, which automatically transmits video at the start of every call.

---

**Note:** Stopping video doesn't create an audio-only call. Even if you stop video, video information is still transmitted to the far side as a still picture, and the call is still a video call.

---

## Procedure

1. Navigate to **Settings > Basic > Video > Video Call Settings**.  
For VVX 1500 phones, navigate to **Menu > Settings > Basic > Video > Video Call Settings**.
2. From the **Video Call Settings** screen, select **Auto Start Video Tx > Disabled**.  
When disabled, your phone does not automatically transmit video at the start of all calls, and the No Video icon  is displayed next to your video during video calls.

## Change Video Clarity

You can change the clarity of your video, including the brightness, contrast, and sharpness of your video stream.

If your camera faces a bright light source, such as a bright window, you may need to increase the camera's brightness, contrast, and sharpness levels so the far side can see you better. To see how you look to the far side, view the picture-in-picture (PIP).

You can adjust the clarity of your video using the following settings:

- **Target Frame Rate**—Sets how smoothly your video displays. You can set a rate between 5 (least smooth) and 30 (smoothest). The default rate is 25.
- **Brightness Level**—Sets how brightly your video displays. You can set a level between 0 (dimkest) and 6 (brightest). The default level is 3.
- **Saturation Level**—Sets how much color your video displays. You can set a level between 0 (lowest) and 6 (highest). The default level is 3.
- **Contrast Level**—Sets the difference in brightness between the light and dark areas of your video. You can set a level between 0 (no contrast increase) and Auto (noise reduction contrast). The default level is 0.
- **Sharpness Level**—Sets the clarity of detail in your video. You can set a level between 0 (lowest) and 6 (highest). The default level is 3.
- **Flicker Avoidance**—Adjusts the flickering of your video captured by the camera sensor. You can select **50 Hz** (flicker avoidance for Europe and Asia) or **60 Hz** (flicker avoidance for North America). The default is 50 Hz.

## Procedure

1. Navigate to **Settings > Basic > Video > Camera Settings**.  
For VVX 1500 phones, navigate to **Menu > Settings > Basic > Video > Camera Settings**.
2. From the **Camera Settings** screen, select and adjust the desired camera settings.

## Changing the Video Call and Picture-In-Picture (PIP) Displays

You can set up your phone so that it displays all video during calls in specific ways. You can choose to do the following:

- Display all incoming video calls on the full screen
- Change the way video displays
- View full-screen video with or without the picture-in-picture (PIP)
- Display the PIP next to, or over, full-screen video

Your video image is displayed at the top-right of the screen in a PIP video, as shown next. The PIP is displayed on your Home screen and during video calls.



### Picture-in-Picture video on the Home screen



When you're in a call with a person that has video-enabled, your video is displayed in the PIP, and the person you're talking with (the far-side) is displayed in the Active Call screen.

### Call window with PIP and far-side video



You can customize how and where you see your PIP video and the far-side video. For example, you can swap the windows in which the video is displayed, or even start and stop the transmission of your video. The following sections show you how to customize video on your phone.

---

**Note:** Depending on the phone or system that is sending video, black bars might appear on the top, bottom, or sides of the video image. This occurs because the aspect ratio of the video received does not match the display area on your phone, and the portions of the video that are not being received display as black bars. If the received video matches your phone's display area, the received video fills the screen. If black bars display, you can remove them by selecting cropped video screen mode.

---

## Change How PIP Video Displays

You can update the way the PIP is displayed when you're in full screen mode, when you view the far-side, or when you view your video on the full screen.

You can change the following PIP settings:

- Local Camera View (Full Screen)—Enables or disables the PIP from displaying when you view video on the full screen. The default setting is Enabled.
- *Local Camera View Mode (Full Screen)* Sets whether you want the PIP to display over, or next to, full-screen video. The default setting is Side-by-Side. You can choose to enable one of these settings:
  - Side-by-Side—Displays the PIP next to, rather than over, full-screen video.
  - PIP—Displays the PIP over full-screen video.

## Procedure

1. Navigate to **Settings > Basic > Video > Local Camera View**.  
For VVX 1500 phones, navigate to **Menu > Settings > Basic > Video > Local Camera View**.
2. From the **Local Camera View** screen, select and adjust the PIP settings.
3. Select **Save**.

## Change How Far-End Video Displays

You can adjust video settings to control the appearance of video received from the far-end.

You can adjust the appearance of the far-side video so that it displays as one of the following:

- **Normal**—The video image displays with correct proportions. Black bars appear on the top, bottom, or sides of the area to maintain the correct aspect ratio if the aspect ratio of the received video does not match the display area. The portions of the video that are not being received display as black bars.
- **Full**—If the received video image is not the same aspect ratio as the display area, the video image is stretched to fill the area. If the aspect ratios match, no stretching occurs.
- **Crop**—The video image is resized to maintain the correct aspect ratio. Any parts of the image that do not fit within the display area are cropped.

You can choose to apply the following settings for video that displays on the full screen and in the Active Call screen:

- **Video Screen Mode (Window)**—Adjusts the video image that displays in the Active Call screen. You can select Normal, Full, or Crop. The default setting is Normal.
- **Video Screen Mode (Full Screen)**—Adjusts the video image that displays on the full screen. You can select Normal, Full, or Crop. The default setting is Normal.

The following pictures show how normal, full, and cropped modes display in the Active Call screen.

### Far-side video display settings



## Procedure

1. Navigate to **Settings > Basic > Video**.  
For VVX 1500 phones, navigate to **Menu > Settings > Basic > Video**.
2. Select **Video Screen Mode** and select a video screen setting and make adjustments.
3. Select **Save**.

## Display All Video Calls in Full Screen Mode

By default, the far-side video always displays in the Active Call screen. You can enable your phone to display all incoming videos on the full screen.

### Procedure

1. Navigate to **Settings > Basic > Video > Video Call Settings**.  
For VVX 1500 phones, navigate to **Menu > Settings > Basic > Video > Video Call Settings**.
2. From the **Video Call Settings** screen, select **Auto Video Full Screen > Enable**.  
When enabled, this setting automatically enables your phone to display far-side video in full screen. When disabled, far-side video is displayed in the smaller Active Call screen.
3. Select **Save**.

## Place a Video Call

If your phone is set to transmit video automatically for calls, then your video stream is sent for all calls placed on your phone. If your phone is set to place audio-only calls by default, you can start sending video during an active call.

### Procedure

1. Tap **New Call**, enter a number or select a contact, and tap  or **Send**.
2. After your contact answers, press the **Video** or **Start Video** soft key.  
Your camera transmits video to your contact. On phones with the VVX camera, the LED light is green when video is transmitting.

## Swap Video

You can switch the locations of your video and the far-side video. If you do this, your PIP is displayed in the Active Call screen, and the far-end video, previously displayed in the Active Call screen, is displayed in the PIP location. When you swap video so that your video is displayed in the Active Call screen, rather than in the PIP, the message “Local camera” is displayed next to your video.

### Procedure

1. During a video call, do one of the following:
  - Tap **Video > Swap**.
  - Tap the PIP.

## Display Video Calls in Full Screen

You can display the far-side video on the full screen, and your PIP continues to display in the corner with the soft keys hidden. In full screen, call details display along the bottom of the screen, including an icon that you can select to exit full screen mode. The following figure displays full screen video on the phone.

**Full screen mode****Procedure**

1. Do one of the following:
  - Tap **Video > Full Screen**.
  - Tap .

## Exit Full Screen View

You can exit full screen view and video in your default video display.

**Procedure**

1. Tap .

If you don't see , tap the bottom of the screen until it is displayed.

## Stop Sending Video

You can stop transmitting video at any time during a call.

Stopping video or closing the camera shutter does not create an audio-only call. Even if you stop video, video information is still transmitted to the far-end and you are still in a video call. When you stop video, the stopped video icon  is displayed, and the far-side cannot see you.

---

**Note:** You can't start and stop far-end video. If the phone is set up to receive far-side video, the far-end video always displays.

---

**Procedure**

1. Do one of the following:
  - Select **Stop Video** or **Video Mute**.
  - Close the Privacy Shutter.

## No Video from the Far Side

If the far side stops sending video, a No Video icon is displayed on your phone, as shown in the next figure. If the far side is unable to send video, a thunderbolt icon is displayed next to the No Video icon, as shown next.

### Call window with No Video icon

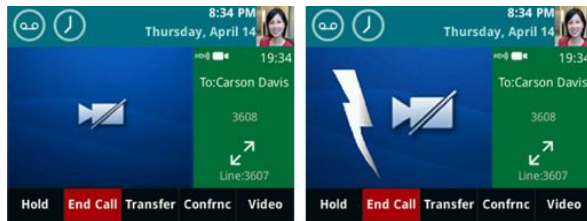

**Note:** Depending on the phone or system that has stopped sending video, you may see a different icon than the one shown above.

## Handling Video and Audio Calls

When you have multiple calls, you can easily manage a video call from the Calls screen. In the Calls screen on VVX 500/501 and 600/601 phones, you can identify the video call by the video stream that is displayed next to the call's details. On VVX 1500 phones, the active video call is displayed on the Active Call screen, and all held calls display above the soft keys.

When two or more calls are video calls, only the active call displays video. On VVX 500/501 and 600/601 phones, all other video calls show a paused grayscale image of the far side taken just before the call was held, as displayed next. When you resume a held video call, the held call becomes active and displays video.

### Video and audio calls on the Calls screen

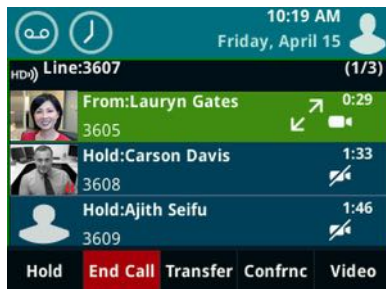

## Handle Conference Calls with Video

When you set up a conference, your phone displays video for only one conference participant at a time, even if more than one participant can send video. The person whose video you see is the last person with video enabled who joined the conference. If you use the Join soft key to set up the conference, you see the video of the person who was held just prior to joining the conference.

---

**Note:** Viewing all video participants requires the use of a Polycom Video Conference Bridge. For more information, contact your Polycom reseller.

---

When your system administrator enables the conference management feature on your phone, you can select whose video to see.

### Procedure

1. During a conference call, select a contact and tap **Select Video**.  
The Select Video soft key does not display when you're currently exchanging video with the selected party, or when the party does not have video capability.  
The person who previously displayed video is replaced with the person you selected.

## Managing Video Calls without a VVX Camera

When you do not have a VVX Camera attached to your VVX 500/501 or 600/601 phone, you can receive video, but you cannot send video. Video always displays when the person you are talking with can send video, and your phone is enabled to receive video.

If you place a video call on hold, the person's video stream stops and is replaced by a paused grayscale image taken just before you held the call, as displayed next. The person's video stream returns when you resume the call.

### Held video call

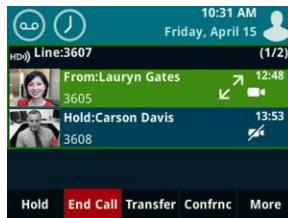

## View Video in Full Screen during Calls

During a video call, you have the option of viewing video on the full screen instead of in the smaller Active Call screen.

### Procedure

1. Do one of the following:
  - Tap .
  - Tap the video area to view video on the full screen.
  - Tap **Video**, and select **Full Screen**.

Full-screen video displays. Call details display at the bottom of the screen, along with an icon that you can select to exit full screen mode, as displayed next. The call details display for five seconds, and then disappear. To see the details again, tap the screen.



## Handling Video and Audio-Only Calls

When you have multiple calls, you can easily manage a video call from the Calls screen. From the Calls screen, you can quickly identify the video call by the video stream that is displayed next to the call details, as shown next.

### Video calls on the Calls screen

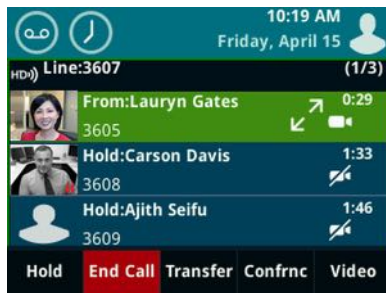

If two or more calls are video calls, only the active call shows a video stream of the far side. All other video calls show a paused grayscale image of the far side. If you resume a held video call, the held call becomes active and displays an active video stream again.

## Place Audio-Only Calls

Your system administrator can determine how your phone handles audio and video. You can change the settings on your phone to handle audio and video calls in one of the following ways:

- **Video-enabled**—All calls you place or answer are video calls. This means that the person you call sees your video on his or her phone, and you see video on your phone from the other person on the call.
- **Audio only**—All calls are audio only and do not display video information. Your phone screen does not display video in the Active Call screen, and you do not have the option to send video. If the person you call sends video, you do not see them.
- **Video and Audio**—You have the option to choose a call mode, either video or audio-only. If this option is set up on your phone, you can choose the call mode on a call-by-call basis, as well as choose a mode to apply to all the calls you place.

Placing audio-only calls applies to SIP calls only. This feature is not available for H.323 calls.

### Procedure

1. Navigate to **Settings > Basic > Video > Video Call Settings**.  
On VVX 1500 phones, navigate to **Menu > Settings > Basic > Video > Video Call Settings**.
2. From the **Video Call Settings** screen, select **Default Call Mode**, and select **Audio Only**.

The mode you choose applies to your next call and all subsequent calls.



# Call Lists and Directories

---

## Topics:

- [Recent Calls](#)
- [Contact Directory](#)
- [Corporate Directory](#)
- [BroadSoft Directories on a VVX Business Media Phone](#)
- [Managing the GENBAND Address Books](#)

All VVX business media phones support a Recent Calls list, a Contact Directory and a Corporate Directory. The phones can also support a BroadSoft Directory and the GENBAND Address Books depending on your server and if enabled by your system administrator.

---

**Note:** The phone may not support all of the features described in this section. Check with your system administrator to find out which features are available on your device.

---

## Recent Calls

All VVX Business Media Phone maintain a Recent Calls list that includes missed, received, and placed calls. Each list holds up to 100 entries.

You can perform the following tasks from the Recent Calls list:

- Sort, order, and filter calls. By default, the list displays all call types with the most recent call displaying first.
- Remove calls from the list.
- Select a call record to view call details.
- Select a call record to automatically call a contact.

## View Recent Calls

In the Recent Calls list, you can view a list of up to 100 missed, received, and placed call entries.

### Procedure

1. Do one of the following:
  - Navigate to **Directories > Recent Calls**.
  - On VVX 500/501 and 600/601 phones, tap  in the status bar.
  - On VVX 1500 phones, press the **Directory** key and tap **Call Lists**.

## Sort Recent Call Entries

You can customize the Recent Calls list to view calls by call type, time, and call name.

When you sort calls by the time of the call, you can order them in ascending (oldest call first) or descending (most recent call first) order. When you sort calls by name, you can order them in ascending (alphabetical) or descending (reverse-alphabetical) order.

#### Procedure

1. Select **Sort** or tap .
2. Under **Sort**, choose **Time** or **Name**.
3. Under **Order**, choose **Ascending** or **Descending**.

## Sort Entries by Call Type

When you filter calls, you can choose to display only missed, received, or placed calls. Or, you can choose to display all call types (the default).

---

**Note:** You cannot save your filtered call list results. If you filter your Recent Calls list so that only a certain call type displays, the next time you display the list, all call types display in the default filter.

---



#### Procedure

1. Select **Type** or tap .
2. Choose **Missed Calls**, **Received Calls**, or **Placed Calls**.

## Edit a Recent Call Entry

You can edit a contact's phone number stored in your Recent Calls list before returning the contact's call.



#### Procedure

1. Select **Info** or tap  next to a call record.
2. Select **Edit** or tap .
3. Edit the number, and select **Dial** or tap .

## Delete a Recent Call Entry

You can delete any recent call entry from the Recent Calls list.

#### Procedure

1. Select **Info** or tap  next to a call record.
2. Select **Delete** or tap .

## Save a Recent Call Entry

You can save a recent call entry to the Contact Directory.

**Procedure**

1. Select **Info** or tap ⓘ next to a call record.
2. From the **Call Details** screen, select **Save**.  
If the person is already in your Contact Directory, but is not a favorite, **Add to Favorites** is displayed.

**View Call Details**

In the Recent Calls list, you can view call details, edit call details before calling a contact, save a contact to your directory, and delete call entries.

**Procedure**

1. Select **Info** or tap ⓘ next to a call record.

**Contact Directory**

You can store a large number of contacts in your phone's Contact Directory, as well as add additional contacts, view and update a contact's information, and delete contacts from the directory.

Contact your administrator for the exact number of contacts you can store in the Contact Directory for your phone model.

---

**Note:** If you can not add or edit contacts in the Contact Directory, your system administrator has set the directory as read-only. Contact your system administrator for assistance making any changes to the contacts stored in the directory.

---

**Search for a Contact in the Contact Directory**

In the Contact Directory, you can search for your desired contact.

**Procedure**

1. Navigate to **Directories > Contact Directory**.  
On VVX 1500 phones, press the **Directory** key and tap **Contact Directory**.
2. In the **Contact Directory**, select **Search**.
3. In the search field, enter your search criteria and select **Submit**.

**Add a Contact to the Contact Directory**

When you add a contact to your Contact directory, you can choose how much information you want to enter for your contact. You are required to only enter a contact number for each new contact.

The following is a list of information you can enter for each contact:

- First and Last Name—The name of your contact
- Contact—Your contact's phone number
- Job Title—Your contact's position

- Email—Your contact's personal or work email address
- Favorite Index—An index number that displays in your Favorites list
- Label—A label or title for your contact

---

**Note:** If your phone does not display all of these contact fields, contact your system administrator. The only required field in the Contact Directory is the Contact field, which includes the contact's phone number.

---

### Procedure

1. Navigate to **Directories > Contact Directory**.  
On VVX 1500 phones, press the **Directory** key and tap **Contact Directory**.
2. In the **Contact Directory**, select **Add** or tap **+**.
3. From the **Add Contact** screen, enter your contact's information in the available fields.  
You are required to only enter a number in the **Contact** field when adding a new contact to the directory. You can choose to enter additionally information.
4. Select **Save**.

## View Contact Information

From your Contact Directory, you can view information, such as name and phone number, for any contacts saved to the directory. Additional information, such as a job title, label, or email address, can also display.

### Procedure

1. Navigate to **Directories > Contact Directory**.  
On VVX 1500 phones, press the **Directory** key and tap **Contact Directory**.
2. From the **Contact Directory**, select a contact.

## Update a Contact's Information

After you add a contact to your Contact Directory, you can update the contact's information.

### Procedure

1. From the **Contact Directory**, select a contact.
2. From the **Contact Information** screen, do one of the following:
  - Select **Edit**.
  - Select **Info > Edit**.
  - Tap .
3. From the **Edit Contact** screen, update the contact's information.
4. Select **Save**.

## Delete a Contact from the Contact Directory

You can delete any contact from the Contact Directory.

### Procedure

1. Navigate to **Directories > Contact Directory**.  
On VVX 1500 phones, press the **Directory** key and tap **Contact Directory**.
2. From the **Contact Directory**, select a contact.
3. From the **Contact Information** screen, do one of the following:
  - Select **Delete**.
  - Tap .
  - Select **Info > Delete**.

A confirmation message is displayed, confirming that you want to delete the contact.
4. Select **Yes** to delete the contact.

## Corporate Directory

Your system administrator can set up your VVX Business Media Phone so that you can access a Corporate Directory. However, you cannot update the Corporate Directory, and your administrator determines which contacts you can see. Check with your system administrator to find out if this feature is available.

### Searching the Corporate Directory

In the Corporate Directory, you can perform a quick or advanced contact search.

#### Perform a Quick Search of the Corporate Directory

A quick search enables you to search for contacts using either their first name or last name.

##### Procedure

1. Navigate to **Directory > Corporate Directory**.  
On VVX 1500 phones, press the **Directory** key, and tap **Corporate Directory**.
2. In the search field, enter your search criteria and select **Submit**.
3. Select a contact and select **View** to view the contact's information.

#### Perform an Advanced Search of the Corporate Directory

An advanced search enables you to choose to search for contacts by first name, last name, or phone number.

##### Procedure

1. Navigate to **Directory > Corporate Directory**.  
On VVX 1500 phones, press the **Directory** key, and tap **Corporate Directory**.

2. In the **Corporate Directory**, select **AdvFind**.
3. In the search field, enter your search criteria and select **Submit**.
4. Select a contact and select **View** to view the contact's information.

## Save Corporate Directory Search Results

You can save your last search results so that the next time you view the Corporate Directory, the results of your last search is displayed.

### Procedure

1. Navigate to **Settings > Basic > Preference > Corporate Directory > View Persistency**.  
On VVX 1500 phones, navigate to **Menu > Settings > Basic > Preferences > Corporate Directory > View Persistency**.
2. From the **View Persistency** screen, select **Enabled**.  
Each time you view the Corporate Directory, your last search results automatically display.

## Clear Corporate Directory Search Results

After you search for a contact, you can clear your search results and start a new search.

### Procedure

1. On the **Search** screen, select **Clear**.

## Add Corporate Directory Contacts to the Contact Directory

You can add contacts in the Corporate Directory to the Contact Directory.

When you save a Corporate Directory contact to the Contact Directory, the first name, last name, and phone number of the contact are automatically saved to the directory. You can add additional contact information after the contact is saved to the directory.

### Procedure

1. In the **Corporate Directory**, search for a contact.
2. From the search results, select the contact and select **View**.
3. Select **Save**.
4. Enter any additional contact information and select **Save**.

## BroadSoft Directories on a VVX Business Media Phone

If enabled by your administrator, you can access, search for, and call contacts in any of your company's BroadSoft directories from any phone.

You can access the following BroadSoft directories from you phone:

- Enterprise Directory—contains a list of all contacts within the organization and enables you to search for contacts by name or department.

- Enterprise Common Directory—contains a list of common contacts within the organization.
- Group Directory—contains a list of groups within an organization and enables you to view and search for contacts within those groups.
- Group Common Directory—contains a list of contacts that are common across various groups within the organization.
- Personal Directory—contains a list of contacts saved in your personal directory on the BroadSoft server.

## View a List of BroadSoft Contacts

You can view a list of contacts within your organization from any BroadSoft Directories available on your phone.

Within the directories, you can view a contact's name, job title, and any available phone numbers or extensions.

### Procedure

1. Navigate to **Directories**.
2. Select one of the following BroadSoft directories:
  - Enterprise Directory
  - Enterprise Common Directory
  - Group Directory
  - Group Common Directory
  - Personal Directory

## Searching the BroadSoft Directory

You can access and search the BroadSoft Directory on the phone, and you can choose to perform a simple or advanced search for contacts.

After the administrator configures the Enterprise directory, you can view a list of contacts by default in the BroadSoft directory. The default contacts list is displayed even when no text is entered in the search box of the directory.

The BroadSoft Directory is not supported on VVX 101, 201, and 1500 phones. Check with your system administrator to find out if this feature is available on your phone.

## Perform a Simple Search of the BroadSoft Directory

A simple search enables you to search for contacts using either their first name, last name, or by typing a few letters in their name. A maximum of 50 contacts are available for viewing at one time.

### Procedure

1. Navigate to **Directories** and select a BroadSoft directory.  
A default list of contacts is displayed.
2. In the search field, enter your search criteria and select **Submit**.

## Perform an Advanced Search of the BroadSoft Directory

An advanced search enables you to choose to search for contacts by first name, last name, or phone number.

### Procedure

1. Navigate to **Directories**, and select a BroadSoft directory.
2. Select **Advanced Search** in the BroadSoft Directory.
3. On the **Advanced Search** screen, choose to search for a contact by first name, last name, or a contact number.
4. In the search field, enter your search criteria and select **Submit**.
5. Choose your contact.

A contact details screen is displayed, as shown next.

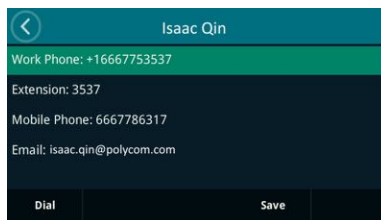

## Add BroadSoft Contacts to the Contact Directory

After you find your BroadSoft contact, you can add the contact to the Contact Directory.

The first name, last name, and phone number of the contact are saved to the Contact Directory. You can go to the Contact Directory to see if the contact was saved correctly and to add additional contact information.

### Procedure

1. In the contact details screen, select **Save**.

## Managing a Personal BroadSoft Directory

If enabled by your administrator, you can view and edit contacts in your Personal Directory on the BroadSoft Server.

### Add a Contact to the Personal BroadSoft Directory

You can add a new contact to the Personal Directory from your phone and store the contact's name and phone number to the directory on the phone and the BroadSoft server.

When you add a new contact to the Personal Directory, you are only required to add a phone number for the contact in the Contact field.

### Procedure

1. Navigate to **Directories > Personal Directory**.



2. On the **Add Contact** screen, enter your contact's information in the available fields.
3. Select **Save**.

## Update a Contact's Information in the Personal BroadSoft Directory

If any of your contact's name or phone number changes, you can update your contact's information stored in the Personal Directory.

### Procedure

1. Navigate to **Directories > Personal Directory**.
2. From the **Contact Information** screen, do one of the following:
  - Select **Edit**.
  - Select **Info > Edit**.
  - Tap .
3. Edit your contact's name or number.
4. Select **Save**.

## Delete a BroadSoft Contact from the Personal Directory

You can delete any contact from the Personal Directory.

### Procedure

1. Navigate to **Directories > Personal Directory**.
2. From the **Contact Information** screen, do one of the following:
  - Select **Delete**.
  - Tap .
  - Select **Info > Delete**.

A confirmation message is displayed, confirming that you want to delete the contact.

3. Select **Yes** to delete the contact.

## Managing the GENBAND Address Books

When your phone is registered with the GENBAND server, you can access your Global Address Book and Personal Address Book on your VVX phone. Check with your system administrator to find out if this feature is available on your phone.

### Using the Global Address Book

GENBAND's Global Address Book (GAB) is a read-only directory similar to the Corporate Directory, which is a company directory enabled and populated with contacts by your system administrator. Using the GAB, you can perform simple and advanced searches and save contacts to the Contact Directory or Personal Address Book (PAB).

You can access the GAB from the Features and Directory menu on all VVX phones, or by pressing the Directory key on the VVX 1500 phone.

### Perform a Simple Search of the Global Address Book

A simple search enables you to search for contacts using either their first name, last name, or by typing a few letters in their name.

#### Procedure

1. Navigate to **Directories > Global Address Book**.  
On VVX 1500 phones, press the **Directory** key and select **Global Address Book**.
2. In the search field, enter your search criteria and select **Submit**.

### Perform an Advanced Search of the Global Address Book

An advanced search enables you to choose to search for contacts by first name, last name, or phone number.

#### Procedure

1. Navigate to **Directories > Global Address Book**.  
On VVX 1500 phones, press the **Directory** key and select **Global Address Book**.
2. In the Global Address Book screen, select **AdvFind**.
3. Select a search option and select **Next**. You can choose to search by a contact's last name, first name, or phone number.
4. Enter your search criteria and press **Next**.  
Your search results display with the contact's name and phone number.

### Save a Global Address Book Contact to the Contact Directory

If you want to modify a GAB contact's information, you need to save the contact to the Contact Directory or the Personal Address Book, if enabled.

When you save a contact from the GAB to the Contact Directory or PAB, you can modify the contact's information and save the new contact information in the PAB or Contact Directory.

#### Procedure

1. After you find your contact, select **View**.
2. In the **Edit Contact** screen, select **Save**.  
The contact is saved to the Contact Directory or your Personal Address Book.

### Save Global Address Book Search Results

For the GAB, you can also enable View Persistency, which enables you to view your most recent search results in the GAB after you have left the Directory screen.

#### Procedure

1. Navigate to **Settings > Basic > Preferences > Global Address Book > View Persistency**.

On VVX 1500, navigate to **Menu > Settings > Basic > Preferences > Global Address Book > View Persistency**.

**2. Select Enable.**

View Persistency is enabled and you can view your most recent search each time you return to the GAB.

## Using the Personal Address Book

The Personal Address Book (PAB) enables you to import contacts from GENBAND to the Contact Directory on your VVX phone. Additionally, you can search for contacts, edit contact information, and save contacts to the PAB.

---

**Note:** Before importing contacts to your Polycom phone, make sure you save all of your contacts to your PAB using your GENBAND Personal Agent on your computer. Saving all of your contacts to the PAB ensures that your contacts are downloaded to the Contact Directory on your phone.

---

You can access the PAB from the Features or Directory menu on all VVX phones and by pressing the Directory key on the VVX 1500 phones.

### View Contacts in the Personal Address Book

#### Procedure

**1. Navigate to Directories > Contact Directory.**

On VVX 1500 phones, press the **Directory** key and tap **Contact Directory**.

**2. Select a contact and select Edit.**

The contact's information, including first and last name, directory number, nickname, and other details are displayed.

### Search Your Personal Address Book

You can search for contacts in the PAB by first name or last name.

#### Procedure

**1. In the Contact Directory screen, select Search.**

Select **More** if you do not see the Search soft key.

**2. In the search field, enter your search criteria and select Submit.**

### Add Contacts to the Personal Address Book

When you add a new contact to the PAB, you must enter a unique nickname that is at least one character long for each new contact. If you try to save a contact without a nickname, a message asking you to enter a nickname is displayed.

#### Procedure

**1. In the Contact Directory, select Add or tap +.**

**2. Enter your contact's information, create a nickname for the contact, and select Save.**

The contact is added to the Contact Directory on your phone and to the PAB on the server.

## Delete Contacts from the Personal Address Book

When you delete a contact, the contact is deleted from your PAB on your phone and the GENBAND Personal Agent.

### Procedure

1. In the **Contact Directory** screen, select a contact and select **Delete**.  
A message asking for confirmation to delete the contact is displayed.
2. Select **Yes** to delete the contact entry.

## Editing Contacts in the Personal Address Book

You can edit contacts in the PAB on your phone or in your GENBAND Personal Agent on your computer. If you modify a contact's information on your phone or computer, the changes are automatically updated in the Personal Agent and in the PAB on your phone.

### Edit Contacts Locally

You can edit PAB contacts locally on your phone. When you edit contacts on your phone, your contact's information is updated in the Personal Agent as well.

### Procedure

1. In the **Contact Directory** screen, select a contact and select **Edit**.
2. Edit the information in the contact fields and select **Save**.

---

**Note:** If adding, editing, or deleting a contact fails, a message is displayed with the reason the modification failed. Depending on the reason for the failure, the database state can change to "out of sync". Contact your system administrator if an "out of sync" message is displayed.

---

### Editing Contacts Remotely

When you edit a contact's information in the GENBAND Personal Agent on your computer, the contact's information is updated on the GENBAND Server.

After the contact information is updated on the server, your PAB contact's information is updated immediately on your phone, and a notification with the nickname of the modified contact is displayed on the phone. When a contact is deleted, the phone deletes the contact from the PAB without any notification.

# Favorites and Contact Lists

---

## Topics:

- [Managing Favorites](#)
- [Using Buddy Lists](#)
- [Managing BroadSoft UC-One Favorites and Contacts](#)

On your VVX phone, you can add contacts as favorites , view and manage BroadSoft UC-One contacts, and watch contacts in your Buddy list.

---

**Note:** Your phone may not support all of the features described in this section. Check with your system administrator to find out which features are available on your phone.

---

## Managing Favorites

Favorites are the contacts in your Contact Directory that you will call most often. You can add contacts as favorites from the Contact Directory, designate an index number for favorites, view favorites on the Home or Lines screen depending on your phone, and delete favorites.

### Add Favorites

Contacts that you add as favorites display on the Home screen on VVX 1500 phones, in the Lines screen on other VVX phones, and in the Favorites list on all VVX phones. On all VVX phones, excluding the VVX 1500, a star is displayed for contacts saved as favorites.

#### Procedure

1. Navigate to **Directories > Contact Directory**.  
On VVX 1500 phones, press the **Directory** key, and select **Contact Directory**.
2. From your **Contact Directory**, select a contact.
3. Select **Add** or **Add to Favorites**.  
A notification is displayed asking if you want to automatically accept the next available index number, or manually enter your own.
4. Select **Yes** to automatically accept an index number or select **Edit Index** to enter a unique index number.  
You can enter a number up to 99 for VVX 101 and 201 phones or 9999 for all other VVX phones.

### Viewing Favorites

You can view favorites in your Favorites list in the Directory or the New Call screen. Favorites display consecutively according to their index number. The contact with the lowest number is displayed first.

## View Favorites

You can view favorites in the Favorites lists from the New Call screen.

### Procedure

1. Select **New Call > Favorites**.

## View Favorites on the Home Screen

On VVX 1500 phones, favorites display on the Home screen below the phone number. On VVX 500/501 and 600/601, you can tap the phone line to view favorites from the Home screen. You cannot view favorites from the Home screen on VVX 101, 201, 300 series, and 400 series phones.

### Procedure

1. From the **Home** screen, tap the phone line.

## View Favorites from the Lines Screen

You can view a list of favorites on the Lines screen on all VVX phones, not including VVX 1500 phones.

### Procedure

1. From the **Home** screen, press .

## Reorder Favorites

You can change the order in which your favorites display on the Home or Lines screen.

### Procedure

1. From your **Contact Directory**, select a contact.
2. From the **Contact Information** screen, select **Edit** or tap .
3. From the **Edit Contact** screen, select **Favorite Index**, and enter a new favorite index number.
4. Select **Save**.

## Delete Favorites

You can delete favorites to make room for new favorites.

### Procedure

1. From your **Contact Directory**, select the contact.
2. From the **Contact Information** screen, select **Edit** or tap .
3. From the **Edit Contact** screen, select **Favorite Index**, and delete the favorite index number.
4. Select **Save**.

---

**Tip:** To quickly delete a contact, on the Lines screen, press and hold the favorite until the Contact Information screen is displayed. Select **Delete** or tap . The contact remains in your directory, but is no longer a favorite.

---

## Using Buddy Lists

A Buddy list is a list of users whose status or presence you can monitor. Users can update their presence setting to status such as Be right back, Out to lunch, or Busy, and you can view their status in real time from your Buddy list. You can also view your buddies' status from the Lines and Home screens, if your buddy is a favorite.

### Add Contacts to Your Buddy List

If you want to monitor other people, you need to make sure they are in your Buddy list. You add people to your Buddy list from your Contact Directory, so you must first add them to your Contact Directory before adding them to your Buddy list.

#### Procedure

1. From your **Contact Directory**, select a contact.
2. From the **Contact Information** screen, select **Edit** or tap .
3. From the **Edit Contact** screen, select **Watch Buddy > Enabled**.

The default setting is Disabled. When enabled, the contact is added to your Buddy list so you can monitor the contact's status.

4. Select **Save**.

### View Your Buddy List

When you enable the Watch Buddy setting for a contact, the contact is displayed in your Buddy list.

#### Procedure

1. From the Lines screen, select **Buddies**.

---

**Tip:** You can quickly dial a buddy from your Buddy list. From the Lines screen, select **Buddies**, select the buddy you want to call, and select **Dial** or tap .

---

### Monitor Contacts on Your Buddy List

You can monitor your buddies from your Buddy list. If a buddy is a favorite, you can also monitor the buddy from the Home and Lines screen.

#### Procedure

1. Do one of the following:
  - Select **Buddies** or navigate to **Settings > Features > Presence > Buddy Status**.
  - On VVX 1500 phones, navigate to **Menu > Features > Presence > Buddy Status**.





- From the **Home** screen, press .

## Buddies' Presence Information

Your buddies display an icon next to their name to indicate their status.

The following table shows the general icons and the status they represent.

### Buddy Status and Icons

Buddy Status	Icon
Available	
Busy	
Away	
Do Not Disturb	
Offline	

## View Your Watcher List

Contacts who can monitor your status are added to the Watcher list.

### Procedure

1. Navigate to **Settings > Features > Presence > Watcher List**.  
On VVX 1500 phones, navigate to **Menu > Features > Presence > Watcher List**.  
A list of contacts that can monitor your status is displayed.

## Block Contacts from Viewing Your Status

You can prevent someone from monitoring you by blocking the contact in your Contact Directory. If you unblock the contact, the contact can add you to their Buddy list and monitor you.

### Procedure

1. From your **Contact Directory**, select a contact.
2. From the **Contact Information** screen, select **Edit** or tap .
3. From the **Edit Contact** screen, select **Block Buddy > Enabled**.  
The default setting is Disabled. When enabled, the contact cannot watch your status, and the contact is displayed in your Blocked List.
4. Select **Save**.

## View a List of Blocked Contacts

Contacts who cannot monitor your status are added to the Blocked List.



**Procedure**

1. Navigate to **Settings > Features > Presence > Blocked List**.  
On VVX 1500 phones, navigate to **Menu > Features > Presence > Blocked List**.  
A list of contacts that cannot monitor your status is displayed.

**Unblock a Contact**

From the Blocked list, you can unblock contacts and allow them to monitor your status.

**Procedure**

1. Navigate to **Settings > Features > Presence > Blocked List**.  
On VVX 1500 phones, navigate to **Menu > Features > Presence > Blocked List**.
2. From the **Blocked List** screen, select a contact.
3. Select **Unblock**.  
The contact can now monitor your status and is displayed in the Watcher list.

**Managing BroadSoft UC-One Favorites and Contacts**

You can see your BroadSoft UC-One contacts marked as favorites in the UC-One Contacts list and on the Lines screen on your phone.



The VVX 101, 201, and 1500 phones do not support BroadSoft UC-One favorites. Contact your system administrator to find out if this feature is available on your phone.

**BroadSoft UC-One Contacts' Presence Information**

UC-One contacts are Enterprise Directory contacts that have Instant Messaging and Presence (IM&P) enabled, and you can view their presence information on your phone. While you can view UC-One contacts presence information on the Lines screen, you cannot change your presence status on the phone. You can change your presence status only in the BroadSoft UC-One client on your computer.

The following table shows the presence icons that display for BroadSoft UC-One contacts on your phone.

**BroadSoft UC-One Contact Presence Icons**

Icon	Description
	Visible
	Away

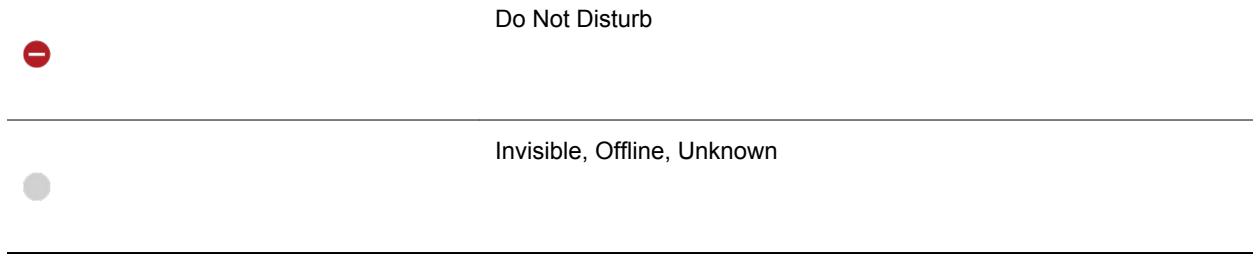

## Viewing BroadSoft UC-One Contacts and Favorites

You can view UC-One contacts and favorites from your phone on the Home and Lines screen and in the Contacts list. You can also view BroadSoft UC-One groups and view contacts in each group.

You cannot mark UC-One contacts as favorites on your phone. You must mark contacts as favorites in the BroadSoft UC-One client on your computer. Contacts marked as favorites in the BroadSoft UC-One client display on your phone after one minute.

**Note:** If the message “Authentication failure” is displayed when you try to view UC-One contacts, make sure you entered the correct BroadSoft UC-One credentials on your phone.

### View BroadSoft UC-One Contacts and Favorites

You can view UC-One contacts with presence information and other UC-One contacts marked as favorites on the Lines screen.

#### Procedure

1. From the **Home** screen, press .

UC-One contacts and favorites display on the Lines screen, as shown in the following figure.



### View BroadSoft UC-One Favorites in the Contact List

In addition to viewing UC-One favorites on the Home screen, you can also view your favorites in the UC-One Contacts list.

#### Procedure

1. Select **Directories > UC-One Contacts**.
2. Select the group name to view the list of contacts for that group, as shown next.



## View BroadSoft UC-One Groups

You can access your BroadSoft UC-One groups on your phone, but you cannot create new groups, delete existing groups, or move contacts from one group to another on your phone. You can alter groups only in the BroadSoft UC-One client on your computer.

### Procedure

1. Select **Directories > UC-One Contacts**.

Your UC-One groups display. If there are no user-defined groups, contacts display under the **All Contacts** group.

## Filter BroadSoft UC-One Favorites

You can filter your list of contacts either by Favorites or by status.

### Procedure

1. Select **Directories > UC-One Contacts**.
2. Select **Filter** or tap .

A filter selection screen is displayed.

3. Choose your desired filter selection:
  - Select **Favorites** to display only your BroadSoft UC-One Favorites on the Home screen and in the UC Contacts list.
  - Select **Online** to display only the BroadSoft UC-One contacts that are currently online on the Home screen and in the UC Contacts list.

## Search for BroadSoft UC-One Contacts

You can search for UC-One contacts from the UC-One Contacts screen.

### Procedure

1. Select **Directories > UC-One Contacts**.
2. Select **Search** or tap .
3. Enter your contact's first or last name.

A list of search results display.

---

**Note:** For more information on Using BroadSoft applications, refer to web pages [BroadSoft UC-One](#) and [BroadSoft Instant Messaging & Presence](#).

---

# Accessing, Sending, and Broadcasting Messages

---

## Topics:

- [Accessing Voice and Video Messages](#)
- [Instant Messaging](#)
- [Broadcasting Messages with Group Paging](#)
- [Broadcasting Messages with Push to Talk](#)

You can access, send, and broadcast a variety of audio, video, and written messages on VVX phones.

---

**Note:** Your phone may not support all of the features described in this section. Check with your system administrator to find out which features are available on your phone.

---

## Accessing Voice and Video Messages

Your phone indicates when you have new voicemail and video messages in the following ways:

- The Message icon on the Home screen displays the number of new messages you have
  - A Message icon with the number of messages is displayed in the status bar
  - The Message icon is displayed next to the phone line on the Lines screen
  - A red flashing Message Waiting Indicator, located at the top-right of your phone
  - An audible alert
- 

**Note:** Contact your system administrator or service provider for information on setting or changing your voicemail greeting.

---

## Access Voicemail and Video Messages

Voicemail is available on all Polycom VVX phones. However, only VVX 1500 phones support video messages. Contact your system administrator to find out if your phone supports video messages.

---

**Note:** For information on remotely accessing your voicemail, contact your system administrator or service provider.

---

## Procedure

1. From the **Home** screen, navigate to **Messages > Message Center**.  
On VVX 1500 phones, press the **Message** key and select **Message Center**.
2. If you have multiple lines on your phone, select the line that has the new message.
3. From the **Messages** screen, select **Connect** and follow the prompts to access your messages.

## Remove the Message Alert

If you are not ready to listen to your messages when you receive new messages, you can temporarily remove the message alert.

### Procedure

1. From the **Home** screen, navigate to **Messages > Message Center** and select **Clear**.  
On VVX 1500 phones, press the **Message** key.  
All message indicators are removed for approximately one to two hours.

## Instant Messaging

You can send and receive instant messages using your phone. Instant messaging is an optional feature. Contact your system administrator to find out whether instant messaging is enabled on your phone.

### Send Instant Messages

When you send a message, you can either select a message from a preset list of short messages, for example, “Call me” and “Can’t chat now”, or you can use the dial pad or onscreen keyboard to enter a custom message.

### Procedure

1. From the **Home** screen, navigate to **Messages > Instant Message**.  
On VVX 1500 phones, press the **Message** key and select **Instant Message**.  
The Instant Messages screen is displayed.
2. If you have multiple lines on your phone, select a line.
3. From the **Instant Messages** screen, select the **New** soft key.
4. Enter a contact’s phone number, URL, or IP address, and select **OK**.  
The phone number, URL, or IP address you entered is displayed on the screen.
5. Do one of the following:
  - Press **Select** to choose a pre-scripted message from the **Message Select** screen.
  - Select **Edit** to compose a custom message, and enter your message.
6. Select **Send**.

### Read Instant Messages

Instant messages display in the order they are received with the first message received displaying first.

### Procedure

1. From the **Home** screen, navigate to **Messages > Instant Message**.  
On VVX 1500 phones, press the **Message** key and select **Instant Messages**.
2. If you have multiple lines on your phone, select a line.

The first message received is displayed.

3. Select the **Next** or **Previous** soft key to read additional messages, if available.

## Reply to Instant Messages

After you read an instant message on your phone, you can send a reply to the message.

### Procedure

1. From the **Instant Messages** screen, select the **Reply** soft key.
2. Enter a message and select **Send**.

## Delete Instant Messages

You can choose to delete older instant messages from your phone.

### Procedure

1. Select a message and select the **Delete** soft key.

## Broadcasting Messages with Group Paging

Group Paging enables you to make pages—one-way audio announcements—to contacts subscribed to a page group. Your administrator can enable your phone to operate in a broadcast mode called Group Paging mode. In this mode, you can broadcast one-way announcements to a specified group of phones, called a Paging Group.

Your system administrator can define up to 25 paging groups. Your system administrator can assign a label to each group to identify the phones in the group, such as All, HR Dept, Shipping Staff, or Executives.

Each group has one of the following priorities:

- **Normal**—By default, broadcasts sent to groups 1 to 23 are considered Normal broadcasts. By default, all phones are configured to receive broadcasts sent to group 1.
- **Priority**—By default, broadcasts sent to group 24 are considered Priority broadcasts. A Priority broadcast interrupts Normal broadcasts or active calls. All phones receive Priority broadcasts unless Do Not Disturb is enabled.
- **Emergency**—By default, broadcasts sent to group 25 are considered Emergency broadcasts. An Emergency broadcast interrupts Normal broadcasts, Priority broadcasts, and active calls and plays out at near maximum volume even if Do Not Disturb is enabled.

To send and receive pages, you need to subscribe to certain paging groups. By default, you are subscribed to paging groups 1, 24, and 25, and you can send and receive pages to those paging groups. Contact your system administrator to find out which paging group you are subscribed to.

## Send a Group Page

When you send a group page, it is automatically sent to the default paging group, which is group 1. You cannot send a page while you are in an active call.

## Procedure

1. From the Lines screen, select the **Paging** soft key.
2. From the **Paging Groups** screen, select the paging group to send the page to.
3. To begin a page, select **Page**.  
Just before the page starts, you'll hear an alert tone, and then the page begins.
4. Begin speaking.
5. To end the page, select **End Page**.

## Receiving Pages

You receive pages on the paging groups you are subscribed to as well as Group 24, Priority pages, and Group 25, Emergency pages. When you enable Do Not Disturb, you only receive Emergency pages. Non-emergency pages do not display or play on your phone.

How you receive a page depends on the priority of the page, whether you are in an active call, and whether your phone is set to receive a page during an active call. When you receive a page, the page is always played through the phone's speakerphone. You cannot play a page through your handset or headset.

When you enable Do Not Disturb on your phone, you receive only Emergency broadcasts. Non-emergency broadcasts do not display or play on your phone.

## Listen to a Page during an Active Call

How you handle a page when you are in an active call depends on the page priority and whether the phone is set up to receive a page during active calls.

The following occurs when you receive a page during a call:

- For Normal pages, the page immediately plays, and you hear audio from both the active call and the page.
- For Priority or Emergency page, the page immediately plays. You hear audio from the active call and the page.
- If the phone is not set up to receive Normal pages during active calls, the page is displayed as Pending.

---

**Note:** You adjust the volume of a Normal, non-emergency page while it plays, and the phone uses the adjusted volume for all subsequent non-emergency pages. However, only your system administrator can change the volume of an Emergency page.

---

## Procedure

1. Do one of the following:
  - For pages that play automatically during a call, hold the call to hear only the page.
  - For Pending pages, select **Accept** or hold the call.

## Receiving Pages When You're Not in an Active Call

When you receive a page and you are not in an active call, the page immediately plays, regardless of the paging priority.

While a page plays, you can:

- Hold the page.
- End the page. This ends the page at your phone only.
- Place a new call.

## Group Paging Settings

This section provides information on changing your default paging group, updating page group subscriptions, and enabling pages to play during active calls.

---

**Note:** The features described in this section require access to the Basic settings menu on the phone. If your phone requires a password to access the Basic settings menu, contact your system administrator for assistance customizing your phone.

---

### Change the Default Paging Group

The default paging group is group 1. You can change the default paging group to any group you want. If you change your default paging group, you are automatically subscribed to the group you selected.

#### Procedure

1. Navigate to **Settings >Basic > Preferences > Paging/PTT Configuration > Group Paging**.

On VVX 1500 phones, navigate to **Menu > Settings > Basic > Preferences > Paging/PTT Configuration > Group Paging**.

2. From the **Group Paging Configuration** screen, select **Default Group**, and select a new paging group number.

When you press Paging, your phone sends pages using the new group.

### Update Paging Group Subscriptions

By default, you are subscribed to Paging Groups 1, 24, and 25. This means that you can send pages to and receive pages sent from these groups. You can change which groups you are subscribed to. However, you cannot disable your subscriptions to Paging Groups 24 and 25.

#### Procedure

1. Navigate to **Settings >Basic > Preferences > Paging/PTT Configuration > Group Paging**.

On VVX 1500 phones, navigate to **Menu > Settings > Basic > Preferences > Paging/PTT Configuration > Group Paging**.

2. From the **Group Paging Configuration** screen, select **Group Subscriptions**.
3. From the **Group Subscriptions** screen, select the group you want to subscribe to, and select **Yes**.

### Enable Pages to Play during Active Calls

The Accept While Busy setting determines what happens when you are in a call and receive a page. This setting is disabled by default, and when disabled, the incoming page is held in a Pending state, it does not disrupt the call, and you cannot hear the page.



When you enable the Accept While Busy setting, a page interrupts calls and you hear the audio of the call and the page.

### Procedure

1. Navigate to **Settings >Basic > Preferences > Paging/PTT Configuration > Group Paging**.  
On VVX 1500 phones, navigate to **Menu > Settings > Basic > Preferences > Paging/PTT Configuration > Group Paging**.
2. From the **Group Paging Configuration** screen, scroll to **Accept While Busy**, and enable or disable the setting.

## Broadcasting Messages with Push to Talk

The Push-to-Talk (PTT) feature enables you to transmit messages and listen to replies much like a walkie-talkie.



Your system administrator sets up the feature, defines up to 25 channels for PTT mode, and assigns a label to each channel that easily identifies the channel, such as All, HR Dept, Shipping Staff, or Executives. By default, you are subscribed to Channels 1, 24, and 25. This means that you can send and receive PTT broadcasts on Channels 1, 24, and 25.

Each group or channel has one of the following priorities:

- **Normal**—By default, broadcasts sent to channels 1 to 23 are considered Normal broadcasts. If two users begin a broadcast on the same group/channel at the same time, the phone with the lower serial number continues to transmit while the other phone enters the receiving state. By default, all phones are configured to receive broadcasts sent to channel 1.
- **Priority**—By default, broadcasts sent to channel 24 are considered Priority broadcasts. A Priority broadcast interrupts Normal broadcasts or active calls. All phones receive Priority broadcasts unless Do Not Disturb is enabled. Phones play Priority broadcasts at the phone's current audio level.
- **Emergency**—By default, broadcasts sent to channel 25 are considered Emergency broadcasts. An Emergency broadcast interrupts Normal broadcasts, Priority broadcasts, and active calls and plays out at near maximum volume even if Do Not Disturb is enabled.

### Send a PTT Broadcast

You can choose a channel to broadcast on before you send a PTT broadcast, or you can hold the Talk soft key to immediately begin broadcasting on Channel 1, the default channel.

While you send a broadcast, you can pick up the handset, or press the Speakerphone  or Headset  key, and continue speaking. You can also press the Mute key  to mute your audio so that the people receiving your broadcast do not hear anything. This behavior is similar to a phone call.

---

**Tip:** To automatically send a PTT broadcast on the default channel, press and hold **Talk**. After the transmitting beep, begin speaking.

---

### Procedure

1. Select **Talk**.
2. From the **PTT Channels** screen, select a channel.

A list is displayed with the default channel, the most recent channel you sent a broadcast on, and other channels you can broadcast on.

3. Press and hold **Talk** to start the broadcast.

Be sure to hold **Talk** throughout the entire broadcast.

A transmitting beep is played then the phone displays the channel information.

4. Begin speaking.
5. When you finish your broadcast, do one of the following:

- Release **Talk**.

When you release Talk while sending the broadcast, the broadcast temporarily stops and enters a 10-second waiting period. During this period, the channel remains open to give others a chance to reply. At any time during the waiting period, you can resume your broadcast by pressing and holding Talk. If no one broadcasts during the waiting period, the channel closes and the broadcast ends.

- Select **End PTT**.

After you select End PTT, you can immediately initiate another broadcast on another channel, even if the previous broadcast is in the waiting period.

## Receiving PTT Broadcasts

To receive a broadcast sent on a particular channel, you need to be subscribed to that channel.

How you receive a PTT broadcast depends on the broadcast priority, whether you are in an active call, and whether your phone is set up to receive broadcasts during active calls.

When you enable Do Not Disturb on your phone, you receive only Emergency broadcasts. Non-emergency broadcasts do not display or play on your phone.

### Listen to a PTT Broadcast during an Active Call

How you handle a broadcast when you are in an active call depends on the broadcast priority and if your phone is set up to receive a broadcast when you are in an active call.

The following occurs when you receive a broadcast during an active call:

- When your phone is set up to receive Normal broadcasts during an active call, the broadcast immediately plays. You hear both the active call and the broadcast.
- When your phone is not set up to receive broadcasts during active calls, the broadcast is displayed as a Pending broadcast.
- When the broadcast is a Priority or Emergency broadcast, the broadcast plays immediately. You hear the active call and the broadcast.

### Procedure

1. Do one of the following,
  - For broadcasts that play automatically during a call, hold the call to hear only the broadcast.
  - For Pending broadcasts, select **Accept** or hold the call.

### Receiving PTT Broadcasts When Not in an Active Call

When you receive a broadcast and you are not in an active call, the broadcast immediately plays, regardless of the broadcast priority.

When you adjust the volume of a non-emergency broadcast, your phone retains the adjusted volume for all subsequent non-emergency broadcasts. However, only system administrators can adjust the volume level of an Emergency broadcast.

## Reply to PTT Broadcasts

When a broadcast ends, the broadcast enters a 10-second waiting period. During this period, the channel remains open to receive or send additional broadcasts.

### Procedure

1. During the 10-second waiting period, press and hold **Talk**
2. Begin talking.  
The broadcast is sent to all people listening on the channel.
3. When you finish talking, release **Talk**.  
The broadcast enters another waiting period until someone broadcasts again. If no activity occurs within the waiting period, the channel closes and no more broadcasts can take place.

## End PTT Broadcasts

After you end a broadcast, the channel remains open so others can respond.

### Procedure

1. Do one of the following:
  - Release **Talk**:  
The broadcast enters a waiting period, and you cannot initiate another broadcast on another channel until the waiting period ends.
  - Select **End PTT**:  
The broadcast ends, and you cannot resume the broadcast by pressing and holding Talk on the same channel. You can immediately initiate another broadcast on another channel.

## Push-To-Talk Settings

This section provides information on the changing your default channel, updating channel subscriptions, and enabling broadcasts to play during active calls.

---

**Note:** The features described in this section require access to the Basic settings menu on the phone. If your phone requires a password to access the Basic settings menu, contact your system administrator for assistance customizing your phone.

---

### Change the Default Channel

When you press and hold Talk, your broadcast automatically transmits on the default channel 1. You can change your default channel to any other channel. When you change the default channel, you are automatically subscribed to the channel you selected.

**Procedure**

1. Navigate to **Settings >Basic > Preferences > Paging/PTT Configuration > PTT Push to Talk**.  
On VVX 1500 phones, navigate to **Menu > Settings > Basic > Preferences > Paging/PTT Configuration > PTT Push to Talk**.
2. From the **PTT Channel Configuration** screen, select **Default Channel**, and select the number of the channel you want to use.

**Update Channel Subscriptions**

You can subscribe to any channel that has been enabled by your administrator and appears in your channels list. When you subscribe to a channel, you can send and receive PTT broadcasts on that channel.

**Procedure**

1. Navigate to **Settings >Basic > Preferences > Paging/PTT Configuration > PTT Push to Talk**.  
On VVX 1500 phones, navigate to **Menu > Settings > Basic > Preferences > Paging/PTT Configuration > PTT Push to Talk**.
2. From the **PTT Channel Configuration** screen, select **Channel Subscriptions**.
3. From the **Channel Subscriptions** screen, select the channel you want to subscribe to, and select **Yes**.

**Enable PTT Broadcasts to Play During Active Calls**

The *Accept While Busy* setting determines what happens when you are in a call and receive a PTT broadcast. The default setting is disabled by default, and when disabled, your phone does not play broadcasts while you are in a call, but holds them in a Pending state instead. When you enable the *Accept While Busy* setting, a PTT broadcast interrupts active calls and you hear the audio of the call and the broadcast.

**Procedure**

1. Navigate to **Settings >Basic > Preferences > Paging/PTT Configuration > PTT Push to Talk**.  
On VVX 1500 phones, navigate to **Menu > Settings > Basic > Preferences > Paging/PTT Configuration > PTT Push to Talk**.
2. From the **PTT Channel Configuration** screen, select **Accept While Busy**, and select **Enable**.

# Phone Applications

---

## Topics:

- [Using the Calendar](#)
- [Navigating the Browsers](#)
- [Using the Launch Pad on VVX 1500 Phones](#)

VVX phones can support optional applications configured by your system administrator. Ask your system administrator if your phone supports any of the applications discussed in this section.

---

**Note:** Some of the features described in this section require access to the Basic settings menu on the phone. If your phone requires a password to access the Basic settings menu, contact your system administrator for assistance customizing your phone.

---

## Using the Calendar

When a VVX Business Media Phone is connected to Microsoft Exchange Server, you can view and join meetings scheduled in Microsoft Outlook from the phone.

### Open the Calendar

You can access the calendar on a VVX Business Media Phone to view and join scheduled meetings.

#### Procedure

1. Select **Calendar** from the Home screen or navigate to **Settings > Features > Calendar**.

The calendar displays your meetings for the day.

---

**Note:** If you do not see the Calendar icon on the Home screen or the Calendar does not display when selected, it is possible your login credentials are incorrect or the Calendar is not connected.

---

### Navigate to Other Views

From Day view, you can also access other calendar views: Month and Meeting view. Note that month view is not available on VVX 201 phones.

#### Procedure

1. Do one of the following:
  - Select **Month** or tap  to access Month view.
  - Select a meeting to display Meeting view.

## Display Meeting View

Meeting view displays the details for a chosen meeting. From Meeting view, you can view the meeting's start and end time, location, organizer, required attendees, and meeting description; view meeting numbers that you can call to join meetings; and join meetings.

### Procedure

1. Do one of the following:
  - From **Day** view, select a meeting.
  - From **Month** view, select a date and select a meeting.

## Meeting Reminders

When you have a scheduled meeting on the calendar, a meeting reminder displays and a tone plays 5 to 15 minutes before a meeting starts.

---

**Note:** If you have enabled meeting reminders but the reminders do not display before meetings, make sure that your login credentials are correct.

---

## Respond to Meeting Reminders

From the reminder, you can join a meeting, view meeting details, snooze the reminder to temporarily remove the reminder from the screen, and dismiss the reminder to permanently remove the reminder from the screen and stop all future reminders for the meeting. The following figure shows a meeting reminder.

### Meeting reminder on VVX 500 series phones

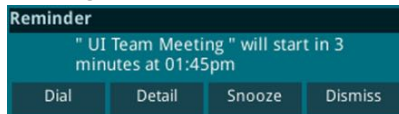

### Procedure

1. Do one of the following:
  - Select **Dial** to join the meeting.
  - Select **Detail** to view information for the meeting.
  - Select **Snooze** to temporarily remove the meeting reminder from your screen for one minute.
  - Select **Dismiss** to permanently remove the reminder for this meeting.

## Choose a Meeting Reminder Type

You can choose a meeting reminder type that determines if an alert tone plays each time a meeting reminder displays.

The following options are available for meeting reminders:

- **Silent**—The meeting reminder is displays without an alert tone.
- **Audible Once**—An alert tone plays the first time a meeting reminder displays but does not play for any additional reminders.

- Audible Always (default)—An alert tone plays each time a meeting reminder displays.

#### Procedure

1. Navigate to **Settings > Basic > Preferences**.
2. Select **Calendar Settings > Reminder Settings**.
3. Select **Reminder Type** and choose a meeting reminder type.

### Choose a Meeting Alert Tone

You can choose the alert tone that plays for meeting reminders.

#### Procedure

1. Navigate to **Settings > Basic > Preferences > Calendar Settings**.
2. Select **Calendar Settings > Alert Tone**.
3. Choose an alert tone and select **Play** to hear the tone.

### Disable Meeting Reminders

Meeting reminders are enabled by default and display reminders for all meetings. You can choose to disable meeting reminders so they do not display for any meetings.

#### Procedure

1. Navigate to **Settings > Basic > Preferences**.
2. Select **Calendar Settings > Reminder Settings**.
3. Select **Reminder > Disable**.

### Joining Calendar Meetings

You can join any scheduled meeting from the calendar or from a meeting reminder.

#### Join Meetings from the Calendar

You can join meetings on VVX Business Media Phone from the Calendar in Meeting view.

#### Procedure

1. From **Day** view, select the meeting.
2. In **Meeting** view, select **Dial**.

#### Join a Meeting from a Meeting Reminder

You can join a meeting from the meeting reminder when it displays before a meeting, if enabled.

#### Procedure

1. Select the meeting number that displays on the reminder.

## Join a Meeting with an Alternate Number

If the meeting organizer has provided alternate numbers you can use to join the meeting, you can view and use alternate numbers to join the meeting.

### Procedure

1. Do one of the following:
  - From **Meeting** view, select **More Actions** and choose a number.
  - From the meeting reminder, select **Details** > **More Actions**, and select a number.

## Navigating the Browsers

VVX phones support the following types of browsers:

- *Idle Browser* Displays non-interactive web content (not supported on VVX 1500 phones)
- *Web Browser* Enables you to search and navigate web pages (not supported on VVX 101 phones)

The Idle Browser shows non-interactive web content on the Lines screen that displays when your phone doesn't have any calls in progress. Your system administrator determines what displays on the Idle Browser for your phone.

The Web Browser is an interactive browser that you can use to search the Internet and view web pages. From the Web Browser, you can select hyperlinks to view more web pages, enter information into text boxes, and scroll through web pages. There are scrolling indicators on the screen that indicate your position on the web page.

Ask your system administrator if the Idle and Web browsers are available on your phone.

## View the Idle Browser

When your phone is idle, you can view an Idle Browser when you switch between the Home and Lines screens. To see the Idle Browser, you need to enable the screen saver.

### Procedure

1. When your phone is not in a call, press .

## Open the Web Browser

When you open the Web Browser, a toolbar with navigation and editing soft keys display for three seconds along the bottom of the screen, as shown next. You can use the navigation and editing soft keys to navigate between web pages and enter information into text boxes in the Web Browser.

### Navigation bar in the Web Browser



### Procedure

1. From the **Home** screen, select **Applications**.  
On VVX 1500 phone, press the **Applications** key.









## Browser Navigation Soft Keys

The navigation soft keys in the Web Browser enable you to view previous web pages, refresh the current page, return to the browser's Home page, or return to your phone's Home screen.

The following table lists the navigation soft keys that display in the Web Browser.

### Navigating the Web Browser

Icon	Action
	Returns to the previous web page.
	Refreshes the current web page.
	Returns to the browser's home page.
	Displays the toolbar permanently so it does not hide every three seconds.
	Enables the toolbar to hide every three seconds. To display a hidden toolbar, you have to press the touchscreen until the toolbar displays. (V VX 1500, 500/501, and 600/601 phones)
	Exits the Web Browser and returns to the phone's Home screen.

## Using the Launch Pad on V VX 1500 Phones

The Launch Pad on V VX 1500 phones is an optional feature that enables you to access local or web applications, directories, and information feeds from your phone. Ask your system administrator if the Launch Pad is enabled on your phone.

When the Launch Pad is enabled on your phone, your system administrator can customize the applications you see. By default, the Launch Pad displays the following applications:

- *Picture Frame* Displays your pictures stored on a USB flash drive.  
Using the Picture Frame application, you can display your pictures as thumbnails, one-by-one, like a slide show, or display just one picture. You can also use the Picture Frame application to set one of your pictures as the background image on your phone.
- *My Info Portal* Gives you access to a variety of information feeds, such as sports, news, weather, stock, and traffic.

Your system administrator can also set up your phone so that you can view feeds from the idle screen, as well as from the Launch Pad. When you view feeds from the Launch Pad or from the idle screen, your phone is considered idle and a screen saver is displayed, if you have set up a screen saver.

## Access the Launch Pad

You can access the Launch Pad from the Applications menu.

### Procedure

1. Press the **Applications** key.

The Launch Pad's main window is displayed.

## Open Applications

The Picture Frame and My Info Portal applications are default applications available in the Launch Pad. Your administrator can enable additional applications for your phone that can also be available in the Launch Pad.

If you haven't enabled the My Info Portal application yet, you need to set up an account before you can access the application.

For information on using custom applications, contact your system administrator.

### Procedure

1. Do one of the following:
  - Select the **Picture Frame** icon.
  - Select the **My Info Portal** icon, and select the feed you want to view.
  - Select an additional application to launch.

## Navigate the Launch Pad

When you are using the Launch Pad application, a group of soft keys display to help you navigate the Launch Pad.

### Procedure

1. Do one of the following:
  - Tap **Home** to display the Launch Pad's main window, with all the Launch Pad applications.
  - Tap **Refresh** to refresh the Launch Pad window so you can access an updated application.
  - Tap **Back** to launch the previous application you viewed.
  - Tap **Exit** to return to the Home screen.

## Display the Launch Pad's Main Screen

When you exit a Launch Pad application without returning to the Launch Pad's main window first, or when a Launch Pad window times out, the next time you access the Launch Pad, the last window you viewed is displayed instead of the Launch Pad's main window.

### Procedure

1. Select the **Home** or **LaunchPad** soft key.

## Enable My Info Portal

Before you can access the applications within My Info Portal, you have to sign up for a My Info Portal account.

---

**Note:** Information you provide when you set up an account is securely transmitted using the HTTPS security protocol.

---

If your system administrator has set up My Info Portal to display on your idle screen, you can also see information feeds from the idle screen.

### Procedure

1. Press the **Applications** key.  
The Launch Pad's main window is displayed.
2. Select the **My Info Portal** icon.
3. From the **My Info Portal - Welcome** screen, select **Sign Up**, and enter your account information.
4. After you enter your account information, select **Sign Up**.  
You can now access the My Info Portal applications, and view the information feeds.

# VVX Business Media Phone Settings

---

## Topics:

- [Password Required to Access Basic Settings](#)
- [Choose a Theme for Your Phone](#)
- [Set the Language](#)
- [Disable Call Waiting](#)
- [Time and Date Display](#)
- [Backlight Intensity and Timeout](#)
- [Changing Your Background](#)
- [Customizing Line Keys](#)
- [Screen Savers](#)
- [Use Your Phone as a Digital Picture Frame](#)
- [Power-Saving Mode](#)
- [Changing Audio Settings](#)
- [Updating Your Buddy Status](#)
- [Security Classification](#)

This section explains how to make some basic customizations, which includes changing the time and date format, setting a language, and adjusting the screen brightness.

## Password Required to Access Basic Settings

Many of the features on the phone can be enabled or customized from the Basic settings menu. However, if your system administrator has set up the phone to require a password to access the Basic settings menu, you cannot change settings without the permission of your system administrator. Contact your system administrator for assistance enabling or customizing features.

## Choose a Theme for Your Phone

On the VVX 500 and 600 series business media phones, you can choose a theme for your phone. The theme controls the way the icons and screens display on your phone. You can choose between the Classic and Modern themes, as shown next. The Classic theme is the default theme.

### Themes on V VX 500 phones

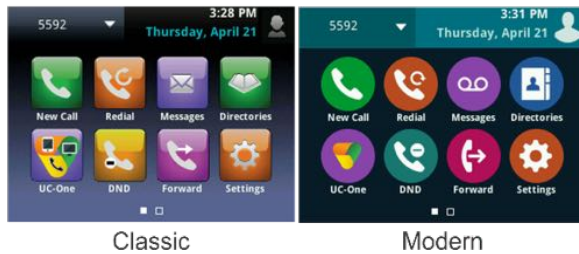

Classic

Modern

### Procedure

1. Navigate to **Settings > Basic > Preferences > Themes**.
2. Select **Classic** or **Modern**.  
A screen displays informing you that the phone needs to restart.
3. Select **Yes**.

## Set the Language

The phone supports several languages that you can choose to display. Check with your system administrator to find out exactly which languages are supported.

### Procedure

1. Navigate to **Settings > Basic > Preferences**.  
On V VX 1500 phones, navigate to **Menu > Settings > Basic > Preferences**.
2. Select **Language** and select a language.  
The language on the phone updates automatically.

## Disable Call Waiting

The Call Waiting feature is enabled by default. If enabled by your system administrator, you can disable Call Waiting.

If you disable Call Waiting, any incoming calls received on your phone while you are in a call are automatically sent to voicemail.

### Procedure

1. Navigate to **Settings > Basic > Preferences**.
2. Select **Call Waiting** and select **Disable**.

## Time and Date Display

The time and date display in the status bar. When the phone cannot obtain a time and date, the time and date display flashes. If this happens, or if the time and date are incorrect, contact your system administrator.

### Change the Time and Date Format

You can customize the time and date by choosing between a variety of time and date formats, including options to display the day, month, or year.

#### Procedure

1. Navigate to **Settings > Basic > Preferences**.  
On VVX 1500 phones, navigate to **Menu > Settings > Basic > Preferences**.
2. Select **Time & Date** and select one of the following:
  - Select **Clock Date** to change the date format.
  - Select **Clock Time** to change the time format.
  - Select **Clock Order** to change the order of the time and date display (not available on VVX 101 and 201 phones).
3. From the **Clock Date**, **Clock Time**, or **Clock Order** screen, select the format you want.

### Disable the Time and Date Display

You can turn off the time and date display so that they do not display at all.

#### Procedure

1. Navigate to **Settings > Basic > Preferences**.  
On VVX 1500 phones, navigate to **Menu > Settings > Basic > Preferences**.
2. Select **Time & Date** and select **Disable**.

## Backlight Intensity and Timeout

You can change settings for the following backlight components:

- **Backlight Intensity**—The brightness of the screen during phone activity and inactivity.
- **Backlight Timeout**—The number of seconds the phone is inactive before the backlight dims to its Backlight Idle intensity. The backlight timeout period begins after your last activity, such as an incoming call.

Backlight Intensity includes the following settings you can choose from:

- **Backlight On**—The brightness of the screen when there is activity.
- **Backlight Idle**—The brightness of the screen when there is no activity.
- **Maximum Intensity**—The brightness scale that applies to both Backlight On and Backlight Idle intensities.

This feature is not available on V VX 101 phones. Check with your system administrator to find out if this feature is available on your phone.

## Set the Backlight Intensity

You can change the Backlight On intensity and the Backlight Idle intensity separately, and you can choose a high, medium, or low intensity, or turn off the backlight entirely. When you change the Maximum Intensity, you modify the entire backlight intensity scale. For example, if you decrease the Maximum Intensity, the low, medium, and high levels for both Backlight On and Backlight Idle intensities decrease.

### Procedure

1. Navigate to **Settings > Basic**.  
On V VX 1500 phones, navigate to **Menu > Settings > Basic**.
2. Select **Backlight Intensity > Backlight On Intensity**.
3. Select the intensity you want, and select **Back**.
4. From the **Backlight Intensity** screen, select **Backlight Idle Intensity**.
5. Select the intensity you want, and select **Back**.
6. From the **Backlight Intensity** screen, select **Maximum Intensity**.
7. Select **Up** or **Down**, or drag your finger along the slider, to increase or decrease the maximum intensity.

## Set the Backlight Timeout

The backlight automatically turns on with any phone activity. By setting the Backlight Timeout, you can determine how long the phone should be idle before the backlight dims to its Backlight Idle intensity. By default, the backlight dims after the phone is idle for 40 seconds.

### Procedure

1. Navigate to **Settings > Basic**.  
On V VX 1500 phones, navigate to **Menu > Settings > Basic**.
2. Select **Backlight Timeout**.
3. Select the number of seconds the phone is idle before the backlight dims.

## Changing Your Background

By default, your screen displays a blue background named Default. You can change the background picture that is displayed on your phone to any image set up by your system administrator. If no background images are set up, only the Default is available.

You can also add personal photos on your phone using the Web Configuration Utility or a USB flash drive.

This feature is not available on V VX 101 and 201 phones. Check with your system administrator to find out if this feature is available on your phone.

## Change the Background Picture

If your system administrator has pre-loaded your phone with background pictures or you have added personal photos onto the phone, you can choose to display a background other than the default.

### Procedure

1. Navigate to **Settings > Basic > Preferences > Background**.

On VVX 1500 phones, navigate to **Menu > Settings > Basic > Preferences > Background**.

Depending how your system is set up, you might have to navigate to **Settings > Basic > Preferences > Background > Select Background**. The **Select Background** screen is displayed instead.

2. Select a background image, if available.

## Adding Personal Photos as Your Background

You can upload a personal photo to use as your background using the Web Configuration Utility or using a USB flash drive. When you set one of your pictures as the background picture, the picture is displayed as *Local File* in the Backgrounds list.

Keep in mind the following when you use a personal photo as the background image:

- Progressive or multiscan JPEG images are not supported.
- The phone screen sizes vary by phone:
  - VVX 300 series and 400 series phone screens are 220 x 108 pixels
  - VVX 500 series phone screens are 320 x 240 pixels
  - VVX 600 series phone screens are 480 x 272 pixels.
  - VVX 1500 phone screens are 800x480 pixels.
- Smaller images are centered and surrounded with black space.
- Larger images are scaled proportionally to fit the screen.
- Horizontal or vertical black bars are added to preserve the original aspect ratio.

## Add a Background Using the Web Configuration Utility

You can add one or multiple images for your phone background using the Web Configuration Utility.

### Procedure

1. Find your phone's IP address by navigating to **Settings > Status > Platform > Phone**.  
On VVX 1500 phones, navigate to **Menu > Status > Platform > Phone**.
2. Enter your phone's IP address into the web browser on your computer.
3. Select **User**, and enter your assigned password or the default (**123**) password.
4. From the menu bar, select **Preferences > Background**.
5. Click **+ Add a new background image**.
6. Click **Select a file from PC/Desktop**, and click **Choose File for Phone Image**.
7. Choose your picture file, and click **Open**.



8. Click **Save**.

The file is added to the list of available backgrounds.

9. On your phone, navigate to **Settings > Basic > Preferences > Background**.

On V VX 1500 phones, navigate to **Menu > Settings > Basic > Preferences > Background**.

10. Select your background image.

The image is displayed as your background.

## Use a USB Flash Drive to Add a Background

You can add personal photos as your background using a USB flash drive on V VX 401/411, 500/501, 600/601, and 1500 phones.

Before you can set a picture on your USB flash drive as the background picture, make sure the picture is on a USB flash drive and is not in a folder on the drive.

---

**Note:** If your phone does not detect the USB flash drive when you attach it to your phone, the USB port on your phone may be disabled. Contact your system administrator.

---

### Procedure

1. Attach a USB flash drive to the USB port on your phone.
2. Navigate to **Settings > Features > Removable Storage Media > Picture Frame**.  
On V VX 1500 phones, navigate to **Menu > Features > Removable Storage**.  
Your pictures display, one-by-one.
3. Tap the arrow keys to find your picture, and then tap .

The picture you selected is displayed on the Home and Lines screens.

---

**Note:** If your pictures on the flash drive are in a subfolder and not in the root directory, the phone displays a message stating that there are no available photos. Make sure the picture you want to display on your phone is not in a subfolder on the flash drive.

---

## Reset Your Background

You can reset your background to display the default image.

### Procedure

1. Navigate to **Settings > Basic > Preferences > Background**.  
On V VX 1500 phones, navigate to **Menu > Settings > Basic > Preferences > Background**.
2. From the **Background** screen, select **Default**.

## Customizing Line Keys

On V VX 500 and 600 series business media phones, you can customize the line keys that display on the Lines screen in the following ways:

- Set a transparent background to show for line keys
- Choose the number of columns that display

This feature is not available on VVX 101 and 201 phones. Check with your system administrator to find out if this feature is supported on your phone.

## Customize the Columns on the Lines Screen

When you add contacts or favorites to line keys on the Lines screen, the contacts display in columns. On VVX 500/501 and 600/601 phones, you can control how many columns of line keys display on the Lines screen.

By default, the phone displays the maximum number of columns and line keys. The following are the maximum line keys and columns that display on each phone:

- VVX 500/501: 3 columns with 12 line keys
- VVX 600/601: 4 columns with 16 line keys

### Procedure

1. Navigate to **Settings > Basic > Preferences > Idle Screen Settings**.
2. Select **Columns**, enter the number of columns you want to display.  
For VVX 500/501, enter a number between 1-3; For VVX 600/601, enter a number between 1-4.
3. Select **Save**.

## Enable Transparent Line Keys

By default, your phone displays line keys with a background. If you have a background picture set on your VVX phone, the background is partially or fully covered depending on the number of line keys you have.

On VVX 500/501 and 600/601 phones, you can change line keys to have a transparent background that enables you to fully see the background you set for your phone.

### Procedure

1. Navigate to **Settings > Basic > Preferences > Idle Screen Settings**.
2. On the **Idle Screen Settings** screen, select **Transparent Lines**, and select **Enabled**.

The line keys are displayed without a background, as shown next.



## Screen Savers

Another way to personalize your phone is to enable a screen saver that can either show default pictures stored on your phone, the idle browser, or pictures stored on a USB flash drive. Ask your system administrator if this feature is available on your phone.

### Enable Screen Savers

The screen saver automatically starts each time your phone is idle for a certain amount of time. When you enable the screen saver, you can choose to have your phone either display default photos stored on the phone, or the idle browser.

You can stop the screen saver at any time by pressing any key or touching the screen. When your phone is idle again for a specified period of time, the screen saver starts again.

#### Procedure

1. Navigate to **Settings > Basic > Preferences > Screen Saver**.  
On VVX 1500 phones, navigate to **Menu > Settings > Basic > Preferences > Screen Saver**.
2. From the **Screen Saver** screen, select **Screen Saver** and select **Enabled**.
3. Select **Wait Time** and enter the number of minutes the phone can wait after no activity before displaying the screen saver.  
You can enter any time between one and 9999 minutes. The default time is 15 minutes.
4. Select **Type** and select either **Default** or **Idle Browser**.
5. Press **Save**.

### Use Personal Photos as Screen Savers

On VVX 401/411, 500/501, 600/601, and 1500 phones, you can enable your phone to display your personal photos as a screen saver. To set up a screen saver of your pictures, you need to set up certain screen saver settings, place your pictures on a USB flash drive, and attach the USB flash drive to the phone.

The pictures you use must have the following file type and size properties:

- File type: BMP, JPEG, or PNG
- Maximum size: 9999 x 9999 pixels

The phone can only display the photos as your screen saver when the USB flash drive is attached to the phone.

You can set up your phone to use a single picture to display or have all pictures display in slide-show style. This is an alternative to setting up a screen saver, and it automatically starts each time your phone is idle a certain amount of time.

#### Procedure

1. Place one or more pictures on a USB flash drive, either in the root directory or in a folder.
2. Attach the USB flash drive to your phone.  
The USB icon  is displayed on the status bar.

**3. Navigate to Settings > Basic > Preferences > Picture Frame.**

On V VX 1500 phones, navigate to **Menu > Settings > Basic > Preferences > Picture Frame**.

**4. From the Picture Frame screen, select Folder, and enter the name of the folder you placed your images in on the USB flash drive.**

If you did not place the pictures in a folder, but placed them in the root directory instead, do not enter a folder name.

**5. Select Time Per Image, and enter the number of seconds you want each picture to display.**

You can enter a minimum of 3 seconds and a maximum of 300 seconds. The default is 5 seconds.

**6. Select Save.**

If the message “No pictures found” displays after you select **Save**, there are no pictures in the folder you specified or in the root directory. Go back and make sure the information you entered is correct.

**7. Navigate to Settings > Basic > Preferences > Screen Saver.**

On V VX 1500 phones, navigate to **Menu > Settings > Basic > Preferences > Screen Saver**.

**8. From the Screen Saver screen, select Screen Saver, and select Enabled.****9. Select Wait Time, and enter the number of minutes the phone should wait, after no activity, before displaying the screen saver.**

You can enter any time between one minute and of 9999 minutes. The default is 15 minutes.

**10. Select Save.**

Your phone displays the screen saver after the number of minutes you specified in the Wait Time field.

---

**Note:** If your phone does not detect the USB flash drive when you attach it to your phone, the USB port on your phone may be disabled. Contact your system administrator.

---

## Disable the Screen Saver

You can stop a screen saver at any time by touching the screen. After your phone is idle for the specified period of time, the screen saver starts again.

You can disable a screen saver—prevent it from starting, even if your phone has been idle for the specified period of time—by doing the following:

- Removing the USB flash drive. The screen saver does not display until you attach the USB flash drive again, and your phone is idle for the period of time you specified.
- Disabling the Screen Saver setting. When you disable the setting, the screen saver does not display, even though the USB flash drive is still attached.

### Procedure

**1. Navigate to Settings > Basic > Preferences > Screen Saver.**

On V VX 1500 phones, navigate to **Menu > Settings > Basic > Preferences > Picture Frame**.

**2. From the Screen Saver screen, select Screen Saver, and select Disabled.****3. Select Save.**

## Use Your Phone as a Digital Picture Frame

On V VX 401/411, 500/501, 600/601, and 1500 phones, you can use the Picture Frame feature to view pictures stored on your USB flash drive at any time without setting up a screen saver. You can display your pictures as thumbnails, one-by-one as a slide show, or display just one picture.

Before you can display your pictures, confirm that your pictures are on the USB flash drive, and that the USB flash drive is attached to your phone.

---

**Note:** If your phone does not detect the USB flash drive when you attach it to your phone, the USB port on your phone may be disabled. Contact your system administrator.

---

### Procedure

1. Select **Settings > Features > Removable Storage Media > Picture Frame**.

On V VX 1500 phones, select **Menu > Features > Removable Storage Media > Picture Frame**.





Your pictures display one-by-one, like a slide show, and navigation icons display beneath your pictures, as shown next.



### Picture Frame Icons

Use the icons in the following table to perform actions in the Picture Frame.

#### Picture Frame Icons

Icons	Action
	View thumbnails of your pictures.
	View the previous picture.
	View the next picture.
	Pause and display the current picture only.
	Starts the display of pictures one-by-one again.

- × Stop displaying the pictures. The pictures do not display again until you access the Picture Frame feature (unless you have a screen saver enabled).



Set the picture that currently displays as the background picture for your phone.

---

## Power-Saving Mode

By default, the phone is set to enter power-saving mode and turn off the screen after being idle for a certain period of time to conserve energy. You can determine the period of time that the phone is idle before the screen turns off, and you can set different idle timeouts for office hours and off hours, such as evenings and weekends.

When power-saving mode is activated, the phone exits power-saving mode if an event occurs—for example, if there is an incoming call or message. If a screen saver is enabled, power-saving mode still occurs.

You can update the following power-saving settings:

- Office Hours—When you start work and how long you're in the office each day.
- Timeouts—The period of time the phone should be idle before the screen turns off.

## Change Your Office Hours

When you update your office hours, you specify when you start and how long you work each day. After your work hours, the phone is idle and goes into power-saving mode.

### Procedure

1. Navigate to **Settings > Basic**.  
On V VX 1500 phones, navigate to **Menu > Settings > Basic**.
2. Select **Power Saving > Office Hours** and select **Start Hour**.
3. Select a day of the week, and using the 24-hour clock, enter a start time from 0 to 23.
4. Select **Save**.
5. From the **Office Hours** screen, select **Duration**.
6. Select a day of the week and enter a duration of 0 to 12 hours per day..
7. Select **Save**.

## Change Timeouts

You can update the period of time the phone is idle before the screen turns off. You can specify different timeouts for office hours (Office Hours Idle Timeout) and non-office hours (Off Hours Idle Timeout). By default, the Office Hours Idle Timeout is much longer than the Off Hours Idle Timeout.

You can also specify a separate timeout period that applies after you press a key or tap the screen. This is called the User Input Idle Timeout. You can choose to set a higher User Input Idle Timeout than the Office Hours and Off Hours Idle Timeouts so that when you're actively using the phone, power-saving mode doesn't initiate as often.

---

**Tip:** If you press a key or tap the screen, the idle timeout period that applies (User Input Idle Timeout or Office Hours/Off Hours Idle Timeout) is the timeout with the highest value.

---

### Procedure

1. Navigate to **Settings > Basic**.  
On V VX 1500 phones, navigate to **Menu > Settings > Basic**.
2. Select **Power Saving > Timeouts**.
3. Select **Office Hours Idle Timeout** and enter the number of minutes (1 to 600 minutes) the phone should wait, during office hours, before starting power-saving mode.
4. Select **Off Hours Idle Timeout**, and enter the number of minutes ( 1 to 10 minutes) the phone should wait, during off-hours, before starting power-saving mode.
5. Select **User Input Idle Timeout**, and enter the number of minutes ( 1 to 10 minutes) the phone should wait after a key press or screen select before starting power-saving mode.
6. Select **Save**.

## Changing Audio Settings

You control certain audio settings on your phone, including the ringtone for incoming calls from all contacts or a specific contact, where call notifications play, and the volume or the ringtone or call audio.

### Change Incoming Call Notifications

You can choose whether you hear sound effects—all phone sounds except call audio—from the handset, headset, speaker, or the active audio device you set. For example, you can configure your phone to ring on your headset instead of the speaker. By default, you hear all sound effects from the speaker.

### Procedure

1. Navigate to **Settings >Basic > Preferences > Audible Ringer**.  
On V VX 1500 phones, navigate to **Menu > Settings > Basic > Preferences > Audible Ringer**.
2. From the **Audible Ringer** screen, select a location to hear sound effects.

### Set a Ringtone for Incoming Calls

A simple way to personalize your phone is to change your phone's ringtone. You can pick unique ringtones for the different lines on your phone. The default ringtone is Low Trill.

### Procedure

1. Navigate to **Settings > Basic > Preferences**.  
On V VX 1500 phones, navigate to **Menu > Settings > Basic > Preferences**.
2. Select **Ring Type**.
3. If there are multiple lines on your phone, select a line.

4. From the **Ring Type** screen, select a ringtone.
5. Select **Play** to hear the ringtone.

## Set a Ringtone for Individual Contacts

You can select unique ringtones for various contacts in your directory, which helps you quickly identify callers as your phone rings.

### Procedure

1. From your **Contact Directory**, select a contact.
2. From the **Contact Information** screen, select **Edit** or tap .
3. From the **Edit Contact** screen, select **Ring Type** and select a ringtone.
4. Select **Play** to hear the ringtone.
5. From the **Edit Contact** screen, select **Save**.

## Change the Volume

You can increase the volume of your ringtone and the audio during a call.

### Procedure

1. Press one of the Volume keys  to increase or decrease the audio.

## Updating Your Buddy Status

Polycom phones enable you to sign into your update your presence status on your phone to let contacts know when you are busy or available.

You can update your status to one of the following:

- Online
- Busy
- Be right back
- Away
- On the phone
- Out to lunch
- Do not disturb

Your phone also sends certain status information automatically to the people watching you—such as if you are in a call, if you enabled Do Not Disturb on your phone, or if your phone is offline because you restarted it.

## Update Your Buddy Status

You can update your status on your phone so that contacts can monitor your status from their phones. Your updated status is displayed in the status bar on your phone, and your contacts are automatically notified of your new status.



---

**Note:** If your status is set to Do Not Disturb, when you enable then disable the Do Not Disturb feature on your phone, your status changes to Online.

---

### Procedure

1. Select **My Status**, or navigate to **Settings > Features > Presence > My Status**.  
On VVX 1500 phones, navigate to **Menu > Features > Presence > My Status**.
2. From the **My Status** screen, select your desired status.

## Automatically Update Your Buddy Status

You can enable your phone to automatically set your status to Away when your phone is idle for a certain length of time. After you touch the screen or press a key on your phone, your status changes to *Available* again.

### Procedure

1. Navigate to **Settings > Basic > Preferences > Presence > Idle Timeout**.  
On VVX 1500 phones, navigate to **Menu > Settings > Basic > Preferences > Presence > Idle Timeout**.
2. From the **Idle Timeout** screen, enable an **Office Hours** and **Off Hours** timeout, and enter the number of minutes your phone should be idle before your status changes to Away.

## Security Classification

For phones registered with the BroadSoft BroadWorks Server, you can view and modify the security classification level for your phone, if enabled by your system administrator.

### View the Security Classification for Your Phone

If you are unsure of your security classification, you can view your assigned classification for all lines on your phone.

### Procedure

1. Navigate to **Settings > Status > Lines**.  
If you have only one line, the security classification displays for that line.
2. If you have more than one registered line, select a line.  
The security classification displays for the selected line.

### Modify Security Classification Level

You can modify your security classification level to choose a lower level during a call to allow users with a lower classification to join a call or to a higher level to restrict you can join the call.

For example, if you are classified as a Top Secret user, you can lower your classification level to Secret or Restricted during a call. You cannot change the security classification when the phone is idle and not in a call.

## Procedure

1. During a call, select **Security**.
2. On the Security Classification screen, choose one of the following options:
  - Top Secret
  - Secret
  - Restricted
  - Classified

A notification displays on all call participants' phones informing them that the classification level of the call has changed.

# Phone Accessories and Computer Applications

---

## Topics:

- [Using a Headset with Your Phone](#)
- [Controlling Your Phone with Polycom Desktop Connector](#)
- [Connecting a Netgear Wi-Fi Adapter to Your Phone](#)
- [Connecting Polycom VVX Expansion Modules to Your Phone](#)

This section describes accessories and applications that you can use to extend your phone's capabilities. Your phone may not support all of the accessories or applications described in this section. Check with your system administrator to find out which of these applications or accessories are available on your phone.

---

**Note:** Some of the features described in this section require access to the Basic settings menu on the phone. If your phone requires a password to access the Basic settings menu, contact your system administrator for assistance customizing your phone.

---

## Using a Headset with Your Phone

You can connect a headset to your VVX phone and use the headset to place and answer calls, handle all calls using a headset, and use electronic hookswitch (EHS).

You can connect an analog headset to all VVX phones or a USB headset to VVX 401/411, 500/501 600/601 and 1500 phones. You can also pair and connect a Bluetooth headset with your VVX 600/601 phone.

See *Feature Profile 37477: Using Headsets with Polycom Phones* on [Polycom Support](#) for a list of compatible headsets.

---

**Note:** For information on your headset's features, as well as how to sync your headset with your phone, see your headset's documentation.

---

## Connecting a Headset

Your phone does the following when connected to analog and USB headsets:

- When an analog headset is connected and in use, the headset key glows green. Note that the headset key does not glow on VVX 101 and 201 phones.
- When a USB headset is connected and in use, the headset key glows blue. For VVX 1500 phones, the headset key glows green.
- When both an analog and USB headset are connected, the USB headset is used automatically for all calls.
- When two USB headsets are connected, the headset you connected first is used automatically for all calls.

After you connect a headset to your phone, you can set up your phone to use the headset automatically when answering and placing calls.

For setup information on how to connect a headset to your phone, see the *Quick Start Guide* for your phone on the [Business Media Phones Support](#) page.

---

**Note:** If your phone does not detect the USB headset when you attach it to your phone, the USB port on your phone may be disabled. Contact your system administrator.

---

## Use Your Headset for All Calls

You can set up your phone so that all incoming and outgoing calls automatically use your headset. To use this feature, you must enable and activate Headset Memory Mode.

### Procedure

1. Navigate to **Settings > Basic > Preferences > Headset > Headset Memory**.  
For VVX 1500 phones, navigate to **Menu > Settings > Basic > Preferences > Headset > Headset Memory**.
2. From the **Headset Memory Mode** screen, select **Enabled**.
3. Press the headset key twice.  
The headset key flashes to indicate that Headset Memory Mode is now activated. All calls placed or answered on your phone use your headset automatically.

---

**Note:** If you or your contacts experience audio or echo issues during calls, such as feedback of your voice or of their own voice, you need to enable echo cancellation on your phone.

---

## Reactivate Headset Memory Mode

Switching to the speakerphone or the handset deactivates Headset Memory Mode.

### Procedure

1. Press the headset key twice.

## Using Electronic Hookswitch

When you use a headset that supports electronic hookswitch (EHS), you can place, answer, and end calls by using the controls on your headset. To use EHS, you need a headset that includes a serial control interface in addition to the standard analog headset jack (RJ-9) interface. The serial control interface requires an EHS adapter that you can purchase from your headset manufacturer.

Headsets that support EHS include a base unit that connects to your phone. The headset connects to the base unit wirelessly, which enables you to use your headset even if you're some distance away from your phone. Typically, you can work wirelessly up to 300 feet (91 meters) from your phone and still use the EHS controls. Check with your headset's user guide for the precise range restrictions.

See Feature Profile 37477: Using Headsets with Polycom Phones on [Polycom Support](#) for a list of compatible headsets.

## Setting the Headset Base Unit Options

Before you connect your headset to your phone and use EHS, you need to set the following options for your specific headset model:

- For Jabra headsets, change the headset mode to **DHSG** on the headset base unit. For details, refer to your headset documentation or contact Jabra support.
- For Plantronics headsets, change the coarse receive level to **3** and the transmit level to **B** on the headset base unit. For details, refer to the guide that comes with your headset.
- For Sennheiser headsets, set the first DIP switch labeled **1** (DHSG) to the down position on the back of the headset base unit. For additional details, see your headset's documentation or contact Sennheiser support.

## Enable Electronic Hookswitch

After you set the base unit options for your headset and connect your headset to your phone, you can enable EHS.

### Procedure

1. Connect your headset and EHS adapter to your phone.

See the Quick Start Guide for your phone on [Polycom Voice Support](#) for information on connecting a headset to your phone.

2. Navigate to **Settings > Basic > Preferences > Headset > Hookswitch Mode**.

For VVX 1500 phones, navigate to **Menu > Settings > Basic > Preferences > Headset > Hookswitch Mode**.

3. Select one of the below modes for your specific headset:
  - Choose **Jabra** if an EHS-compatible Jabra headset is attached with an EHS cable or adapter.
  - Choose **Plantronics** if an EHS-compatible Plantronics headset is attached with an EHS cable or adapter.
  - Choose **Sennheiser** if an EHS-compatible Sennheiser headset is attached with an EHS cable or adapter. If your phone does not have a menu selection for Sennheiser, select **Jabra** instead.
  - Choose **Regular Mode** (default) if another headset is attached.

## Change the Headset Mode

Headsets that come with a docking station have two modes: soft phone and desk phone mode. In order for you to control your phone using your headset, your headset must be in soft phone mode. If you cannot operate the phone from your headset, it is possible your headset is in desk phone mode.

### Procedure

1. Press and hold the headset hookswitch until you hear a sound or message on the headset.

## Controlling Calls with Electronic Hookswitch

After you have followed the procedures for connecting your headset and enabled EHS, you can use the controls on your headset to answer, mute, and end calls. If supported on your headset, you can also place calls on hold. See your headset's user documentation for information on controlling calls from your headset.

When you are in an active call and you receive an incoming call, you cannot use the hookswitch control on your headset to place the active call on hold and answer the incoming call. Pressing the hookswitch control on the headset ends the active call and answers the incoming call. To place the existing call on hold and answer the incoming call, answer the call on your phone.

## Disconnect Your Headset

If you want to disconnect or change your headset, you need to properly detach your headset from your phone.

### Procedure

1. Navigate to **Settings >Basic > Preferences > Headset > Hookswitch Mode**.  
For VVX 1500 phones, navigate to **Menu > Settings > Basic > Preferences > Headset > Hookswitch Mode**.
2. Select **Regular Mode**.
3. Remove the EHS adapter from the serial port on the back of the phone.

## Using Bluetooth Headsets with VVX 600 Phones

VVX 600/601 phones support Bluetooth headsets as well as analog and USB headsets. If your system administrator has enabled Bluetooth capability for your phone, you can use a Bluetooth headset to handle calls. When a Bluetooth headset is connected and in use, the headset key  glows blue. If you have multiple types of headsets connected to your phone, the Bluetooth headset is used automatically for all calls.

This section provides you with information on how to enable Bluetooth on your VVX 600/601, how to pair and connect your Bluetooth headset, how to use your Bluetooth headset with your phone, and how to disconnect and remove your headset.



### Enable Bluetooth and Connect a Headset

In order to use a Bluetooth headset with your phone, you need to enable Bluetooth, pair your headset, and connect your Bluetooth device to your phone. You can pair up to four Bluetooth headsets with your phone; however, you can connect only one headset at a time.

The following instructions are intended as a guide, and do not apply to all Bluetooth devices. You can usually find instructions for your headset on the device manufacturer's web site.



### Procedure

1. Navigate to **Settings >Basic > Bluetooth Settings > Bluetooth Radio**.  
The Bluetooth Radio screen is displayed.
2. Tap **On**.  
The Bluetooth icon  is displayed in the status bar. After the icon displays, you can pair and connect your Bluetooth headset.
3. Turn your Bluetooth headset on and place the headset in **Discovery** mode.  
Refer to your headset documentation for information on how to place your headset in discovery mode.
4. Navigate to **Settings > Basic > Bluetooth Settings > Manage BT Headsets**.

5. Tap **Scan** to find your headset.  
All nearby devices in discovery mode are added to the list, and the Bluetooth icon  is displayed next to each unpaired headset.
6. Select your headset and tap **Add** to begin the pairing process.  
After your headset is added, the Bluetooth Available icon  is displayed.
7. Select your headset and select **Connect**.  
The Bluetooth Headset icon  is displayed next to your headset after the headset is paired and connected. The Bluetooth Headset icon is also displayed in the status bar. If you select the icon, the Bluetooth Settings screen is displayed.

## Managing Calls with Your Bluetooth Headset

When your Bluetooth headset is turned on, paired, and connected with your phone, you can perform the following tasks:

- Use the headset to handle calls, including muting and adjusting the call volume.
- Initiate and end calls on your headset by pressing the Headset key , or using a control on the headset.
- Switch to handset or speakerphone mode during a headset call by picking up the handset or pressing the Speakerphone key .

When you turn the headset off, the headset is no longer connected but remains paired to your phone. When you turn the headset back on, the headset is reconnected.

## Disconnect and Remove Your Bluetooth Headset

You can disconnect your Bluetooth headset from your phone, but still keep it paired. When you disconnect a headset, it remains paired so you can easily connect it to your phone again.

You can also remove your headset so that it is no longer paired or connected. When you remove your headset, it won't display in the Manage BT Headsets screen. To connect it back to your phone, you'll need to scan for the device, add it, and connect it again.

### Procedure

1. Navigate to **Settings > Basic > Bluetooth Settings > Manage BT Headsets**.
2. From the **Manage BT Headsets** screen, select your headset, and select **Disconnect**.  
Your headset remains paired to your phone but is no longer connected.
3. Select your headset, and select **Remove**.  
Your headset is removed from the list and is no longer paired or connected with your phone.

---

**Tip:** You can quickly disconnect your headset by turning your headset off. When you turn your headset back on, the headset is connected again.

---

# Controlling Your Phone with Polycom Desktop Connector

The Polycom Desktop Connector (PDC) enables you to use your computer mouse and keyboard to navigate and enter information on your phone. The PDC is compatible with any language your phone and computer supports. Contact your system administrator to find out if your phone supports the PDC.

This feature is not available on VVX 101 and 201 phones. Check with your system administrator to find out if this feature is available on your phone.

## Setting Up and Enabling the Polycom Desktop Connector

Before you can enable and use the PDC, you need to download the PDC application from the [Polycom Voice Applications](#) website, install the application on your computer, and activate PDC on your phone.

To enable the PDC, you need to enter your computer access credentials to the phone. You can provide this information to your phone using one of two methods: Direct or Indirect. The method you use depends on how your phone and computer are set up.

After you install the software, you need to make changes to your phone to establish a connection to your computer and provide an exception to your firewall or anti-virus software to unblock the PDC program.

### Connect Using the Direct Method

If your phone and computer are connected using an Ethernet cable, use the direct method to enable the PDC. Using this method, your phone automatically detects your computer's access credentials.

#### Procedure

1. On your computer, click **Start > Programs > Polycom > Polycom Desktop Connector**.

The PDC icon is displayed as an active program on your taskbar as shown next.

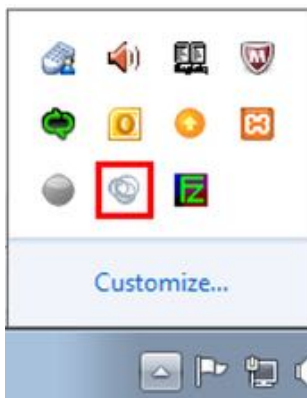

2. On your phone, navigate to **Settings > Basic > PDC Configuration**.  
For VVX 1500 phones, navigate to **Menu > Settings > Basic > PDC Configuration**.
3. On the **PDC Configuration** screen, set the **Status** field to **Enabled** and select **Save**.  
Your settings are saved and the Basic screen is displayed.



4. On the **PDC Configuration** screen, select **Reconnect**.

A dialog box is displayed on your phone screen asking if you wish to share your remote keyboard and mouse.

5. Select **Yes**

A dialog box is displayed asking you to specify your phone's position.

6. Specify whether your phone is to the left or right of your computer monitor.

A dialog box is displayed on your computer asking to allow remote control of your phone.

7. Click **OK** to complete the setup process.

The PDC icon turns red, shown next, indicating that you have successfully enabled the PDC program.

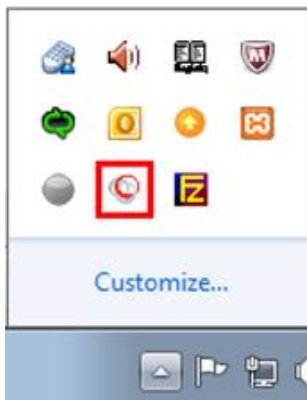

## Connect Using the Indirect Method

If your phone and computer are connected through a switch, use the indirect method to enable the PDC. This method requires you to find your computer's IP address and manually enter your computer access credentials.

After you find your phone's IP address, you can start the PDC program and connect your phone to your computer using the indirect method.

### Procedure

1. On your computer, click **Start > Programs > Polycom > Polycom Desktop Connector**.

The PDC icon is displayed as an active program on your taskbar as shown next.

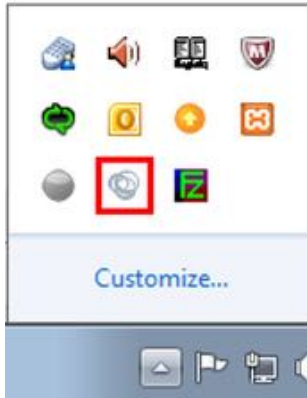

2. On your phone, navigate to **Settings > Basic > PDC Configuration**.  
For VVX 1500 phones, navigate to **Menu > Settings > Basic > PDC Configuration**.
3. From the **PDC Configuration** screen, set the **Status** field to **Enabled**.
4. In the **Phone Orientation** field, specify whether your phone is to the left or right of your computer monitor.
5. In the **Desktop User** field, enter your Windows login name.
6. In the **Server Address** field, enter your computer's IP address or FQDN.  
The IP address enables your phone to locate and identify your computer on the network.
7. Select **Save**.  
Your settings are saved and the Basic screen is displayed, and a message is displayed asking you to allow sharing with your computer.
8. Select **Yes**.  
A dialog box is displayed on your computer asking if you wish to allow remote control of your phone.
9. Click **OK** to complete the setup process.  
The PDC icon turns red, shown next, indicating that you have successfully enabled the PDC program.

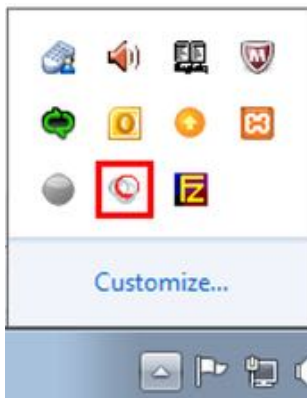

## Disable the Polycom Desktop Connector

If you disable the PDC, you can no longer use your mouse and keyboard to control and enter information on your phone.

### Procedure

1. Do one of the following:
  - On your computer, right-click the PDC icon on your taskbar and click **Exit**.
  - On your phone, navigate to the PDC Configuration menu and set the **Status** to **Disabled**.

In the system tray, the PDC icon turns grey.

## Using the Polycom Desktop Connector

After you've configured and enabled the PDC, you can use your computer mouse and keyboard to click menus and enter text in the editable fields—the fields with a flashing cursor—on your phone.

### Access Your Phone Screens

You can use your mouse to navigate your phone and access your phone's screens.

### Procedure

1. Move your mouse pointer off the edge of your computer monitor in the direction of your phone—left or right—that you indicated in the setup process.

The pointer leaves your computer monitor and displays on the phone's screen.

---

**Note:** If your computer taskbar is on the same side as your phone, the taskbar will block your cursor from accessing your phone. Move your computer taskbar elsewhere to allow your cursor to access the phone.

---

## Using Keyboard Shortcuts to Perform Tasks on Your Phone

The Polycom Desktop Connector application extends your keyboard and mouse functionality from your computer onto your phone.

You can perform the following tasks using the application:











- You can right-click a field on your computer and select the cut or copy information and paste the information onto your phone. You can also cut, copy, and paste text from your computer onto your phone using keyboard shortcuts.
- Copy and paste information between fields on your phone screen by right-clicking the field and choosing a clipboard command.
- Delete information on your phone by highlighting the information using your mouse and pressing the Delete or Backspace key on your keyboard.
- Use the Home and End keys on your keyboard to position your cursor at the beginning or the end of fields on your phone.
- Enter numeric information such as phone numbers using the number keys on your keyboard.
- Use the Arrow keys to move within and between text fields.
- Use your mouse scroll wheel to navigate through menus.
- Adjust the volume level on your phone by holding Alt + Up arrow key or Alt + Down arrow key.



**Note:** When you use PDC, you cannot enter information in phone fields that don't have a flashing cursor, and you cannot place calls using the New Call soft key.

Your keyboard function keys are also mapped to specific phone keys and soft keys, as outlined in the following tables. The key mappings vary by phone model.





To use the Function and Alt key mappings, your cursor must be on the phone's display screen.

#### Function and Alt Key Mappings for VVX 1500 Phones

Function Key	Phone Key	Alt Key	Phone Key
F1	Left-most soft key	Alt + F1	
F2	Second soft key from the left	Alt + F2	
F3	Third soft key from the left	Alt + F3	
F4	Fourth soft key from the left	Alt + F4	
F5	Right-most soft key	Alt + F5	
F6		Alt + F6	
F7		Alt + F7	
F8		Alt + F8	New Call soft key
F9	Talk soft key (if PTT is enabled)	Alt + F9	End Call soft key
F10	NA	Alt + F10	Settings

Function Key	Phone Key	Alt Key	Phone Key
F11		Alt + F11	
F12		Alt + F12	N/A

### Function and Alt Key Mappings for VVX Phones

Function Key	Phone Key	Alt Key	Phone Key
F1	First soft key from the left on your phone's current screen	Alt+F1	N/A
F2	Second soft key from the left on your phone's current screen	Alt+F2	Redial
F3	Third soft key from the left on your phone's current screen	Alt+F3	Transfer
F4	Fourth soft key from the left on your phone's current screen	Alt+F4	Conference
F6		Alt+F6	Do Not Disturb
F7	Directories menu	Alt+F7	
F8	Messages menu	Alt+F8	New Call soft key
F9	Talk soft key (if PTT is enabled)	Alt+F9	End Call soft key
F10	ACD Sign In (if enabled)	Alt+F10	Settings.
F11	Applications	Alt+F11	
F12		Alt+F12	ACD Sign Out (if enabled)

## Enter Text in a Different Language

You can also enter text in different languages onto your phone using your keyboard.

**Note:** The PDC does not allow you to type Chinese characters into fields on your phone using the PinYin character entry method on your computer keyboard. Instead, copy and paste these Chinese characters from a computer document into the applicable phone fields using clipboard functions.

### Procedure

1. On your computer, click **Start > Control Panel > Region and Language > Keyboard and Languages > Change keyboards**.
2. Choose a computer keyboard language, as shown next.

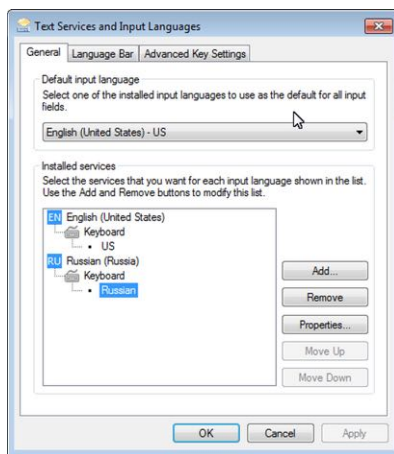

3. Move your cursor onto your phone's display screen.  
The PDC program changes your keyboard language when you move your cursor onto your phone's screen.
4. On the phone, enter text in your chosen language.  
The following graphic shows Russian characters entered on a VVX phone.

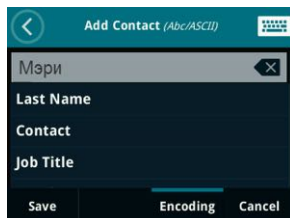

**Tip:** To change your keyboard language back to the original, press the keyboard shortcut **Left Alt + Left Shift** to toggle your keyboard language.

## Connecting a Netgear Wi-Fi Adapter to Your Phone

A Wi-Fi adapter can connect any device with an Ethernet port to your existing wireless network. Use a Wi-Fi adapter with a VVX phone to wirelessly connect your VVX phone to your existing wireless network environment.

### Connect the Wi-Fi Adapter

This section takes you through the steps to connect a VVX phone to a Wi-Fi adapter. The NETGEAR WNCE2001 is supported by Polycom and is used as the Wi-Fi adapter in the procedure.

---

**Note:** Depending on the peripheral devices you have attached to with VVX phone, the phone may not have enough power for the Wi-Fi adapter through the USB port. Therefore, Polycom recommends you use the external power supply that comes with the adapter. This is also a requirement when using a phone without a USB port.

---

#### Procedure

1. Disconnect any wireless connection to the router and/or remove the Ethernet cable currently connected to the computer.

You can restore the connection after the adapter installation is complete.

2. Connect the adapter to your computer using the Ethernet cable and USB cable.

If your computer does not have a USB port, you can use the power adapter that comes with the Wi-Fi adapter for power.



3. Wait until both the Power and LAN LEDs on the Wi-Fi adapter are solid green.
4. Make sure the computer gets the IP address.
5. Open your browser.  
The NETGEAR WNCE2001 Wi-Fi adapter setup page is displayed automatically. Refer to the [NETGEAR WNCE2001 User Guide](#) if you open your browser and do not see the WNCE2001 Wi-Fi Adapter set up page.
6. Follow the instructions on the setup page.
7. After completing the setup, disconnect the Ethernet and USB cables from your computer.
8. Connect the Ethernet and USB cables on the WNCE2001 to the VVX phone.

If your VVX phone doesn't have a USB port or the USB port is disabled, you can use the power adapter that comes with the Wi-Fi adapter to power the unit.



---

**Note:** Wi-Fi Protected Setup (WPS) is a simple and secured way to connect a device to an existing network. If you have a NETGEAR router, this feature is called Push 'N' Connect. Look for the  symbol on the router to make sure the NETGEAR router supports WPS. For non-NETGEAR routers, refer to the user manual to determine if the router supports WPS.

---

## Connecting Polycom VVX Expansion Modules to Your Phone

The Polycom VVX Expansion Modules, with a LCD color or paper display, are consoles you can connect to VVX business media phones to add additional lines. VVX Expansion Modules enable you to handle large call volumes on a daily basis and expand the functions of your phone.

VVX 101, 201, and 1500 phones do not support VVX Expansion Modules. Check with your system administrator to find out if your phone is set up to support VVX Expansion Modules.

---

**Note:** The VVX Expansion Modules are not supported on VVX phones running UC Software 5.0.x. The expansion modules are supported only on VVX phones running UC Software 4.1.6, 4.1.7, and 5.1.x and later.

---

### VVX Expansion Module Hardware Features

The following features are available on the VVX Expansion Modules with a paper display:

- VVX Expansion Modules provide you with 40 line keys that you can set up as registrations, favorites, or busy lamp field contacts.
- You can connect up to three expansion modules to your phone to support an additional 120 line keys per phone.

The following figure illustrates the features, components, and keys available on the VVX Expansion Modules with a paper display. The table lists each numbered feature shown in this figure.



### VVX Expansion Module with paper display features

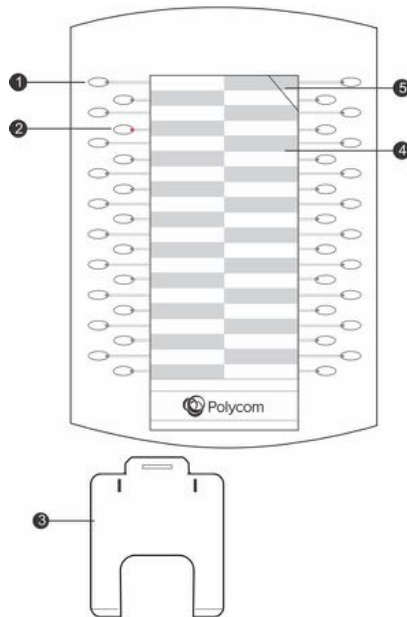

### VVX Expansion Module Hardware Feature Descriptions

Reference Number	Feature	Feature Description
1	Line key	Selects available line key contacts, functions, and assignments.
2	LED Indicators	Indicates a line or busy lamp field contact's status. The following lists the LED Indicator behaviors shown on the expansion modules: <ul style="list-style-type: none"> <li>• <i>Solid Green</i> Indicates an active call in progress.</li> <li>• <i>Fast-flashing Green</i> Indicates an incoming call.</li> <li>• <i>Flashing Green</i> Indicates the remote party placed the call on hold.</li> <li>• <i>Solid Red</i> Indicates the phone of a monitored busy lamp field contact is placing a call or is in a call.</li> <li>• <i>Flashing Red</i> Indicates a held call.</li> </ul>
3	Base Stand	Hooks into the back of the expansion module to stand up the display.
4	Plastic Cover Overlying Directory Card	Protects the directory card. The directory card is a paper sheet that displays line numbers, busy lamp field contacts, favorites, and line key functions.
5	Plastic Cover Cut Out	Helps insert or remove the plastic cover.

### VVX Color Expansion Module Hardware Features

The following features are available on the VVX Color Expansion Modules:

- VVX Color Expansion Modules feature an easy-to-navigate 480x272 LCD display.
- Each color expansion module provides you with 28 line keys and three display pages, supporting a total of 84 lines that you can set up as registrations, favorites, or busy lamp field contacts.
- You can connect up to three color expansion modules to your phone to support an additional 252 line keys per phone.

The following figure illustrates the features, components, and keys available on the VVX Color Expansion Modules. The table lists each numbered feature shown in this figure.

**VVX Color Expansion Module features**

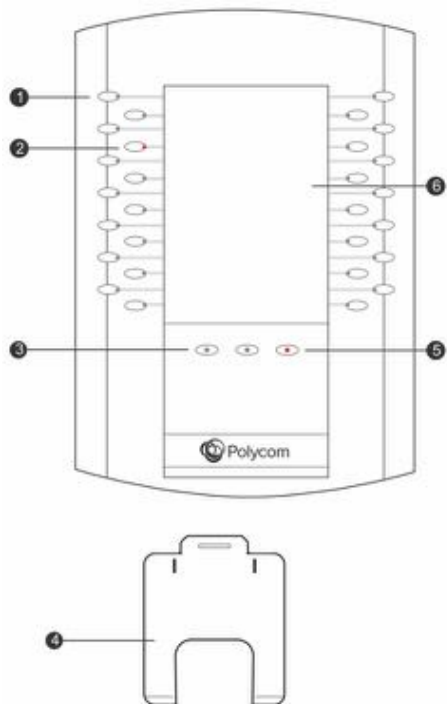

**VVX Color Expansion Module Hardware Feature Descriptions**

Reference Number	Feature	Feature Description
1	Line Key	Selects available line key contacts, functions, and assignments.
2	LED Indicators	Indicates a line or busy lamp field contact's status. The following lists the LED Indicator behaviors shown on the expansion modules: <ul style="list-style-type: none"> <li>• <i>Solid Green</i> Indicates an active call in progress.</li> <li>• <i>Fast-Flashing Green</i> Indicates an incoming call.</li> <li>• <i>Flashing Green</i> Indicates the remote party placed the call on hold.</li> <li>• <i>Solid Red</i> Indicates the phone of a monitored busy lamp field contact is placing a call or is in a call.</li> <li>• <i>Flashing Red</i> Indicates a held call.</li> <li>• <i>Flashing Green and Red</i> Indicates the phone of a monitored busy lamp field contact is on an active call or is receiving an incoming call.</li> </ul>

Reference Number	Feature	Feature Description
3	Page Keys	Navigates between pages on the expansion module.
4	Base Stand	Hooks into the back of the expansion module to stand up the display.
5	LED Page Indicators	<p>Indicates a page's status.</p> <ul style="list-style-type: none"> <li>• <i>Fast-Flashing Green</i> Indicates an incoming call on a page not currently displayed. Press the page key with the fast-flashing green LED indicator to view the contact with an incoming call.</li> <li>• <i>Slow-Flashing Green</i> Indicates a monitored busy lamp field contact on a page not currently displayed is receiving an incoming call.</li> <li>• <i>Solid Red</i> Indicates the current page displayed.</li> </ul>
6	Color Display	Displays line numbers, busy lamp field contacts, and favorites.

## Connect VVX Expansion Modules

VVX Expansion Modules are powered and signaled by VVX phones and require minimal setup. After you connect an expansion module to a VVX phone, the module is automatically configured to work with the phone.

For more information on setting up VVX Expansion Modules, see the [Quick Start Guide for Polycom\\_VVX Expansion Modules](#).

**Note:** You cannot connect paper display and color display expansion modules together on the same phone.

### Procedure

1. Connect an auxiliary cable from the **AUX** port on the phone to the **AUX 1** port on the expansion module.

The LED lights on the module's line keys flash red and green as the module starts up. The VVX Color Expansion Modules take approximately 20 seconds to power up, and the VVX Expansion Modules with a paper display take approximately three seconds to power up.

## Connect Additional Expansion Modules

After the first module is on, you can connect up to two additional modules to your VVX phone.

### Procedure

1. Connect an auxiliary cable from the **AUX 2** port on the first module connected to the phone to the **AUX 1** port on the second module.
2. Connect an auxiliary cable from the **AUX 2** port on the second module to the **AUX 1** port on the third module.

The LED lights on the line keys light up for each connected module as the expansion modules start up.

## Assigning Contacts and Favorites to VVX Expansion Modules

The default view on your phone screen, which is the Lines screen, displays line registrations, busy lamp field contacts, and favorites. Each function occupies a display space on the Lines screen. VVX phones support a maximum number of display spaces, which are listed in the following table. When you reach the maximum number of display spaces on your phone, the next function you add is assigned to the first available line key on your expansion module.

### Maximum Number of VVX Phone Display Spaces

Supported Phone Model	Maximum Display Spaces Supported
VVX 300 series	6
VVX 400 series	12
VVX 500 series	12
VVX 600 series	16

**Note:** After you fill all the display spaces on your phone and assign functions to all the lines on your expansion module, you can find additional favorites in the Contact Directory.

## Assign Favorites to VVX Expansion Modules

You can assign favorites to line keys on VVX Expansion Modules and automatically call contacts using the line keys on the expansion modules. When you assign favorites on your phone, favorites are assigned to the next available line key on the expansion module regardless of the index number. You can reorder your favorites once they are created by changing the value of their index number.

### Procedure

1. Press and hold an available line key on your expansion module.
2. From the **Add Contact** screen, enter the contact's information, including a unique favorite index, and select **Save**.

VVX 500/501 and 600/601 phones automatically assign a favorite index. The favorite is assigned to the next available line on your expansion module and not necessarily the line corresponding to the line key you pressed to assign the favorite.

## Identify Line Key Assignments

You can identify which registrations, busy lamp field contacts, and favorites are assigned to each line key on your expansion module in the Status menu on your VVX phone.

### Procedure

1. Navigate to **Settings > Status > Line Key Information**.
2. Press a line key on the expansion module.

The assignment and line number for the line key you pressed is displayed on your phone's screen.

3. Press the line key twice to return to the previous menu, or select **Back**.

## Generate the VVX Expansion Module Directory Card

Using the Polycom Web Configuration Utility, you can generate and download a PDF file with your VVX Expansion Module line key information. You can print and insert the PDF file as a directory card on your expansion module.

---

**Note:** On Polycom phones with UC Software 5.1.1 or later and registered with Skype for Business Server, access to the Web Configuration Utility is disabled by default as a security precaution. Contact your system administrator for help enabling the Web Configuration Utility.

---

### Procedure

1. In your Internet browser, enter your phone's IP address into your browser's address bar.  
To find your phone's IP address, navigate to **Settings > Status > Platform > Phone**.
2. Log in as a **User**, enter the default password **123**, and click **Submit**.
3. Click **Utilities > EM Directory**.
4. Select the VVX Expansion Module you want to generate a PDF for.  
For example, *EM1* is chosen in the following figure.

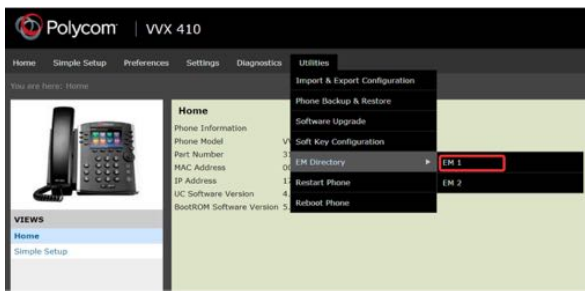

5. In the confirmation dialog box, select **Yes** to download the directory card.
6. Select **Save > Open**.  
The directory card is displayed.

## Insert the Directory Card on the VVX Expansion Module

After you download the directory card, you can print and insert the directory card on your VVX Expansion Module.

### Procedure

1. Place the tip of a paper clip under the plastic cover cut out of the VVX Expansion Module plastic cover to remove it.
2. Place the directory card on your VVX Expansion Module.
3. Align the tabs on either side of the plastic cover with the corresponding indents on the expansion module and bend the plastic cover into place to reinsert the cover over the directory card for protection.

## Navigate VVX Color Expansion Module Paging

The VVX Color Expansion Modules display three pages of line information on the LCD screen for each module connected to a VVX phone. Each page of the expansion module contains 28 registrations, busy lamp field contacts, or favorites assigned to line keys.

### Procedure

1. Press a Page key beneath the screen on the VVX Color Expansion Module.

### Smart Paging

The Smart Paging feature arranges line key assignments and distributes pages on the VVX Color Expansion Modules based on the number of expansion modules connected to a VVX phone. Smart Paging is automatically enabled for VVX Color Expansion Modules connected to VVX phones with UC Software 5.1.0 or later.

Smart Paging does not affect how pages are ordered on VVX Expansion Modules with paper displays.

---

**Note:** If you assigned functions to line keys using the Flexible Line Key feature, the line key assignments display on the designated line key on the expansion module and are not affected by Smart Paging.

---

When Smart Paging is enabled, the pages on the VVX Color Expansion Module are distributed across all connected expansion modules. This feature is described and shown in the following scenarios:

- If you only have one expansion module connected to your VVX phone, the pages are ordered sequentially on the module, as shown in the next figure. Press the first, second, or third **Page** key to view the corresponding pages.



- If you have two expansion modules connected to your VVX phone, the pages are ordered non-sequentially. As shown in the next figure, the pages display on the two expansion modules in the following order:
  - Pages 1, 3, and 4 display on the first expansion module.
  - Pages 2, 5, and 6 display on the second expansion module.

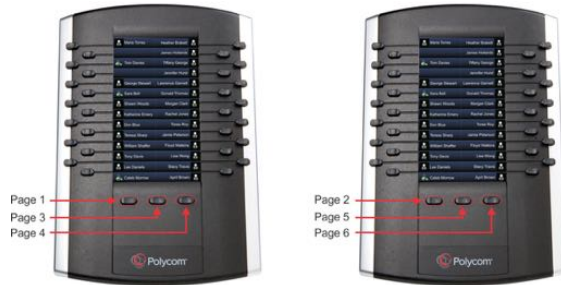

- If you have three expansion modules connected to your VVX phone, the pages are ordered non-sequentially. As shown in the next figure, the pages display on the three expansion modules in the following order:
  - Pages 1, 4, and 5 display on the first expansion module.
  - Pages 2, 6, and 7 display on the second expansion module.
  - Pages 3, 8, and 9 display on the third expansion module.



## Alternate Paging

When Smart Paging is disabled, the ordering of the pages on the expansion modules is not affected by the number of expansion modules connected to your VVX phone. With Alternate Paging, the expansion modules' pages are ordered sequentially from 1 to 9. The next figure shows Alternate Paging on three expansion modules.

### Alternate Paging on VVX Color Expansion Modules



## Changing the Backlight Intensity on VVX Expansion Modules

When you change the backlight intensity settings on your VVX phone, the backlight on your VVX Color Expansion Module connected to your phone automatically changes to match the new settings.

# Accessibility Features

---

## Topics:

- [Features for Hearing-Impaired Users](#)
- [Features for Mobility-Impaired Users](#)
- [Features for Vision-Impaired and Blind Users](#)

Polycom products include a number of features to accommodate any type of user. The following sections describe accessibility features for hearing, vision, or mobility-impaired users available on VVX Business Media Phone.

## Features for Hearing-Impaired Users

The following table lists the accessibility features for hearing-impaired users.

### Accessibility Features for Hearing-Impaired Users

Accessibility Feature	Description
Visual message indicators	An indicator light on the phone indicates that new messages are waiting. Icons on the screen also indicate that the phone has new messages.
Adjustable ring tone and volume	You can choose from a variety of ring tones for the phone. You can also change the volume of the ringer to suit your needs and choose different ring tones for contacts.
Adjustable call volume	If you're in a call, you can raise or lower the volume of the voice on the far end and of other sounds you hear.
Visual notifications	Indicators on the screen (such as flashing bars or icons) let you know when calls are incoming, outgoing, active, or held. Indicators can also indicate phone status and if certain features are activated.
Visual ringing	Certain VVX models have visual ringing that enables the screen to flash bright orange for incoming calls (contact your system administrator).
Electronic hookswitch support	If you use a headset that supports electronic hookswitch (EHS), you can use the controls on your headset to answer and end calls. In addition, you may be able to mute calls and control volume from your headset.
Headset Memory Mode	If you use a headset, you can set up your phone so that all calls use your headset.



Accessibility Feature	Description
Hearing Aid Compatible (HAC) handsets	All VVX handsets are Hearing Aid Compatible (HAC) and have telecoils that magnetically couple to most forms of wearable hearing aids per FCC section 508 (compliant to ADA Section 508 Recommendations: Subpart B 1194.23).
TTY support	phones support commercial TTY devices such as Ultratec Superprint. In addition, the phones provide acoustic coupled TTY support.

## Features for Mobility-Impaired Users

The following table lists the accessibility features for mobility-impaired users.

### Accessibility Features for Mobility-Impaired Users

Accessibility Feature	Description
Auto-answer feature	VVX Business Media Phone can auto-answer calls so you don't have to choose an option to answer a call.
Dedicated headset jack that enables the auto-answer function	If you use a headset, you can set up your phone so that all calls use your headset.
Touchscreen	With a large touchscreen, you can select, swipe, and press to perform phone functions and activate features.
Large keys	VVX phones have large keys that are well-spaced on the phone console.
Built-in speakerphone	A built-in speakerphone allows you to use the phone without having to use a handset or headset.
Adjustable phone stand	VVX phones have stands that you can adjust to various angles so your phone sits at a comfortable angle on your desktop (see your phone's <i>Quick Start Guide</i> on <a href="#">Polycom Voice Support</a> web page).
Polycom Desktop Connector application	You can use your computer's mouse and keyboard to enter information and navigate screens on your VVX phone.

## Features for Vision-Impaired and Blind Users

The following table lists the accessibility features for visually-impaired and blind users.

**Accessibility Features for Vision-Impaired and Blind Users**

Accessibility Feature	Description
Adjustable backlight settings	You can change the brightness of the screen by adjusting backlight intensity settings.
Auto-answer feature	A VVX Business Media Phone can auto-answer calls so you don't have to choose an option to answer a call.
Tactile "5" key with raised bumps	The "5" key has two bumps that let you easily discern the position of other keys on the keypad.
Large keys	Large keys on the phone console enable you to easily access phone features and functions.
Physical line keys	VVX 300 series and 400 series phones have physical line keys that you can press to answer and end calls.
Physical feature keys	Many features on VVX phones are accessible by pressing feature keys on the phone console.
Tactile-discernible number, feature, and navigation keys	Keys on the phone console are easily discernible by their size and shape.
Illuminated feature keys	Many feature keys are illuminated when activated, so you're easily alerted when a feature is enabled.

# Maintaining VVX Business Media Phone

---

## Topics:

- [Investigate Warnings](#)
- [Remove Warnings](#)
- [Restart VVX Business Media Phone](#)
- [Update the Configuration for VVX Business Media Phone](#)
- [Test the Hardware](#)
- [Clean the Touchscreen](#)
- [View Software Details](#)
- [Updating the Phone Software](#)

When the phone is not operating properly, you can investigate or troubleshoot issues along with any other tasks your administrator may ask you to perform.

## Investigate Warnings

When a phone is unable to perform certain tasks, a Warning icon  displays in the status bar.

The warning icon lets you know that your phone has one or more important issues. You can view details about the issues from the Warnings screen.

If you have a VVX 600/601, the icon has a counter indicating the number of warning messages you have, and you can tap the icon to view the messages.

### Procedure

1. Navigate to **Settings > Status > Diagnostics**.  
On VVX 1500 phones, navigate to **Menu > Settings > Status > Diagnostics**.
2. Select **Warnings**.  
The **Warnings** screen is displayed listing any issues.

## Remove Warnings

After you view phone warnings, you can temporarily remove the Warning icon from the status bar. However, the warning still displays in the Warnings list until the issue is fixed. The Warning icon is displayed each time your phone has a warning that you haven't viewed.

### Procedure

1. In the **Warnings** screen, select **Clear Icon** to remove the Warning icon from the status bar.

## Restart VVX Business Media Phone

Your system administrator may ask you to restart the phone if it malfunctions or to assist in troubleshooting.

---

**Caution:** Before you restart the phone, contact your system administrator. If the phone is malfunctioning, you may be able to restore normal operation without restarting it. In addition, your administrator may want to troubleshoot the phone before you restart it. You do not need to restart the phone to update its configuration.

---

### Procedure

1. Navigate to **Settings > Basic**.  
On VVX 1500 phones, navigate to **Menu > Settings > Basic**.
2. Select **Restart Phone**.  
A confirmation message is displayed.
3. Select **Yes**.  
The restart process begins, and the process ends when the Home screen is displayed.

## Update the Configuration for VVX Business Media Phone

Your system administrator may ask you to update the configuration for your phone to apply any changes to system settings, which you can do without restarting it.

### Procedure

1. Navigate to **Settings > Basic**.  
On VVX 1500 phones, navigate to **Menu > Settings > Basic**.
2. Select **Update Configuration**.  
A confirmation message is displayed.
3. Select **Yes**.  
The configuration is updated. The phone may restart, depending on which settings have changed.

## Test the Hardware

Your system administrator may ask you to access a diagnostics menu on the phone to test its hardware. You can test the touchscreen, microphones, speaker, handset, third-party headset (if connected), keypad mappings, and LEDs. Contact your system administrator for instructions on how to perform these tests.

### Procedure

1. Navigate to **Settings > Status > Diagnostics**.

On VVX 1500 phones, navigate to **Menu > Settings > Status > Diagnostics**.

2. Select **Test Hardware** and select one of the following:
  - **Audio Diagnostics**
  - **Display Diagnostics**
  - **Touch Screen Diagnostics**
  - **Brightness Diagnostics**
  - **LED Diagnostics**
  - **Keypad Diagnostics**

## Clean the Touchscreen

The touchscreen on VVX 1500, 500/501, and 600/601 phones requires minor maintenance, but you may need to clean the touchscreen periodically. Use a clean, dry, microfiber cloth—the kind you would use to clean glass surfaces—to wipe the touchscreen. Do not use chemicals to clean the touchscreen.

Before you clean the screen, disable it so you don't activate phone functions while you wipe the touchscreen.

### Procedure

1. Navigate to **Settings > Basic**.  
On VVX 1500 phones, navigate to **Menu > Settings > Basic**.
2. Select **Screen Clean**.
3. Wipe the screen with a clean, dry, microfiber cloth.
4. Press any key on the phone dial pad to enable the touchscreen again.

---

**Note:** If the touchscreen is dirty after cleaning, dampen a soft, lint-free cloth with an isopropyl alcohol and water solution of 50:50 then wipe the screen with the cloth. Always use the dampened cloth to apply the solution; never apply the solution directly because it could seep inside the screen or stain the system. In addition, do not use chemicals to clean the touchscreen.

---

## View Software Details

You can view the details for the software version on your phone, the latest software update available for your phone, and the status of the latest update.

### Procedure

1. Navigate to **Settings > Status > Software Update**.  
For VVX 1500 phones, navigate to **Menu > Settings > Status > Software Update**.

# Updating the Phone Software

You can update the software on your phone when a new software version is available. When new software is available, a notification is displayed on your phone, and you have the option to update your software, postpone the software update, or exit the notification.

## Update the Phone Software

When the software update notification is displayed on your phone, you can choose to update your phone's software at that time.

### Procedure

1. When prompted to update your software, select **Update**.  
The phone reboots and the software is updated on the phone.

## Update Software Later

If you exit the software update, you can press the SWUpdate soft key to update your phone's software at any time after you exit the software update notification.

### Procedure

1. Press the **SWUpdate** soft key.

## Postpone Software Updates

Instead of updating your software immediately, you can choose to postpone the update for a later time. You can choose to postpone the software for 15 minutes or up to six hours. You can postpone the software update up to three times. After the third time, the notification is displayed without the Postpone option.

If you do not update the phone's software after the postpone time, a notification with a countdown is displayed, and the phone automatically reboots and updates the software when the countdown ends.

### Procedure

1. When prompted to update your software, select **Postpone**.
2. Select one of the time options.  
The notification is removed from the phone screen and is displayed again during the remaining five minutes of the postpone time selected.

---

**Note:** If you postpone a software update and the time period you chose ends while you're on an active call, a software update notification with a countdown is displayed after the call ends. After the countdown ends, the phone reboots and updates the software.

---

## Exit the Software Update Notification

When the software update notification is displayed, you also have the option to exit the notification without choosing to update or postpone the software.

**Procedure**

1. When prompted to update your software, select **Exit**.

When you exit the notification, the SWUpdate soft key is displayed on the Lines screen.

# Troubleshooting

---

## Topics:

- [Speakerphone](#)
- [USB Port](#)
- [Check the Status of the Calendar](#)
- [GENBAND Address Book](#)
- [Polycom Desktop Connector](#)
- [Troubleshoot Audio and Echo Issues](#)
- [Bluetooth Headset Issues](#)
- [Recording Issues and Solutions](#)

This section lists potential issues, problems, and common difficulties and possible solutions to guide you towards resolving those issues.

## Speakerphone

If your speakerphone doesn't work, your system administrator may have disabled it. If this is the case, a message is displayed informing you that Handsfree is disabled after you press the speakerphone key. In this case, use the handset or a headset to handle calls.

## USB Port

If you attach a USB device to your VVX 401/411, 500/501, 600/601 or 1500 phone, and the phone does not detect the attached USB device, your system administrator may have disabled the USB port on your phone. In this case, you cannot attach a USB flash drive to your phone to use the following features:

- Call recording
- Picture frame
- USB headset
- VVX Camera for video calls on VVX 500/501 and 600/601 phones
- USB charging device on the VVX 600/601

Contact your system administrator for help on enabling the USB port on your phone.

## Check the Status of the Calendar

When you do not see the Calendar icon on the Home screen or if you are not receiving meeting reminders, it is possible that phone is not connected to the Microsoft Exchange Server.



**Procedure**

1. Navigate to **Settings > Features > Calendar**.
2. From the **Calendar** screen, select **Connect**.

## GENBAND Address Book

This section includes solutions to troubleshooting issues with GENBAND on your phone.

**View the Status of the Personal Address Book**

If you are having issues accessing the Global Address Book (GAB), you can view the status of the GAB in the Status menu on your phone and contact your system administrator for further troubleshooting help.

**Procedure**

1. On your phone, navigate to **Settings > Status > Global Address Book**.  
On VVX 1500 phones, navigate to **Menu > Status > Global Address Book**.  
The status information and the server URL for the GAB is displayed.

## View the Status of the Personal Address Book

You can view the status of the Personal Address Book on your phone to determine any issues with the PAB. Contact your system administrator for further troubleshooting help.

**Procedure**

1. Navigate to **Settings > Status > Contact Directory**.  
On VVX 1500 phones, navigate to **Menu > Status > Contact Directory**.  
The following information is displayed:
  - Status
  - Server Control Method
  - Server URL
  - Registration Index and User ID

## Polycom Desktop Connector

If you encounter any issues using the Polycom Desktop Connector (PDC), see the following table for possible solutions to common problems.

**Common PDC Problems and Solutions**

Issue	Corrective Action
The computer and phone cannot establish a connection.	Verify the Polycom Desktop Connector settings on your phone. You may need to reboot your phone or press the <b>Reconnect</b> soft key.

I can't enter information in a phone field using my computer keyboard.	Check to see if the phone field has a flashing cursor. You can use PDC only to enter information in a phone field if the field has a flashing cursor.
I can't place a call.	If you're using PDC, you can't place a call using the <b>New Call</b> soft key. To place a call, enter the phone number and select the <b>Dial</b> soft key or tap  .
I want to change the phone that is connected to the Polycom Desktop Connector.	<p>Disable the Polycom Desktop Connector, which is already connected to your computer and is in active state on your phone.</p> <p>Setup and enable the phone you want to connect to Polycom Desktop Connector. Once your computer receives an initial communication from the newly configured phone, it asks you to confirm the connection by displaying the message "You were controlling &lt;MACaddress1&gt; with your computer. Do you want to change to controlling &lt;MACaddress2&gt;?" Click <b>OK</b>.</p>

## Troubleshoot Audio and Echo Issues

In some cases when you are using your headset during a call, your contacts may experience audio or echo issues, such as feedback of your voice or of their own voice. If your contacts hear an echo during a call when using your headset, you need to enable echo cancellation on your phone.

### Procedure

1. Navigate to **Settings > Basic > Preferences > Headset > Echo Cancellation**.  
For VVX 1500 phones, navigate to **Menu > Settings > Basic > Preferences > Headset > Echo Cancellation**.
2. Select **Enabled**.

## Bluetooth Headset Issues

If you encounter any issues using a Bluetooth headset, see the following table for possible solutions to common problems.

### Common Bluetooth Headset Issues and Solutions

Issue	Corrective Action
The Bluetooth settings do not display on my phone	<p>Do one of the following:</p> <ul style="list-style-type: none"> <li>• Check with your system administrator to see if the Bluetooth feature is enabled on your phone.</li> <li>• Make sure the Bluetooth Radio setting is on.</li> </ul>

Issue	Corrective Action
My headset doesn't pair automatically.	If your headset is an older model, you may need to enter a password before the headset can pair with your phone. Refer to your headset documentation for more information.

## Recording Issues and Solutions

If you encounter any issues recording calls, see the following table for possible solutions to common problems.

### Common Recording Issues and Solutions

Issue	Corrective Action
The message "USB device is full. Recording canceled" is displayed when I pressed Start.	Check that there is sufficient space on the USB flash drive.
The recording stopped during a call.	<p>If the USB flash drive becomes full during recording, recording stops and the message "USB device is full. Recording stopped" is displayed.</p> <p>Delete previous recordings to make space on the USB drive.</p>
The message "USB device removed unsafely. Recording canceled" displayed when I removed my USB flash drive during a call.	Do not remove the USB flash drive while recording. If you want to remove the drive during a call, press <b>Stop</b> , and then remove the drive.
The message "Unsupported USB device attached" displayed.	Refer to <i>Feature Profile 37477: Using Headsets with Polycom Phones</i> on <a href="#">Polycom Support</a> for a list of USB devices supported on Polycom phones.